



## LA GAMMA | THE RANGE

- **APPLICAZIONI IN FRESATURA**  
MILLING APPLICATION
- **APPLICAZIONI IN RETTIFICA**  
GRINDING APPLICATION
- **APPLICAZIONI IN TORNITURA**  
TOURNING APPLICATION
- **SISTEMA MAGNETICO PER PRESSE  
AD INIEZIONE PLASTICA**  
MAGNETIC SYSTEM FOR INJECTION  
MOLDING MACHINES
- **PRESSE A DEFORMAZIONE**  
HYDRAULIC PRESSES FOR SHEET  
METALFORMING
- **SOLLEVAMENTO A MAGNETI  
PERMANENTI**  
PERMANENT LIFTING MAGNETS
- **SOLLEVAMENTO A BATTERIA**  
BATTERY POWERED LIFTING
- **SOLLEVAMENTO LAMIERE**  
STEEL SHEET LIFTING
- **SOLLEVAMENTO BRAMME**  
SLAB LIFTING
- **MOVIMENTAZIONE E AUTOMAZIONE**  
HANDLING & AUTOMATION
- **DEMAGNETIZZATORI**  
DEMAGNETIZERS

# ELEMENTI DI STAFFAGGIO BULLONERIA VARIA

## CLAMPING TOOLS / NUTS AND BOLTS



### INDICE | INDEX

#### ELEMENTI DI STAFFAGGIO / CLAMPING TOOLS

Appoggi dentati Toothed supports	S110	05
Appoggi a vite Screw supports	S120 S121 - S122	05 06
Prolunghe Extension pieces	S125	07
Puntali Support caps	S151 - S152	07
Appoggi a vite pesanti Heavy screw supports	S130 - S131	08
Staffe Clamps	S210 - S211 S220 - S230 S240 - S250 S260 - S270 S280 - S281	09 10 11 12 13
Morsetti laterali Side buckles	ML10	14
Staffaggi assortiti Assorted clamping tools	S410	15
Appoggi dentati assortiti Assorted toothed support blocks	S440	16

#### BULLONERIA VARIA / NUTS AND BOLTS

Barre Bars	BF10-BF20	18
Viti Bolts	S310 S311 S312 S315 - S316	19 20 21 22
Prigionieri Studs	S320 S321 S5909-S5911-S5914-S5917	23 24-25 26
Dadi Nuts	S330 - S340 S350 - S351	27 28
Tasselli Slot nuts	S360 - S361 S362 - S363	29 30
Rondelle Washers	S370 - S380 - S390 S375C - S375D - S375G	31 32
Contenitori per viti Set of bolts	S420 S425 S430	33 34 35
Viti per torretta Turret bolts	VT10 - VT6050	36
Chiavi per torretta Turret keys	CA10 - CA20 CL10 - CP10 CP30 - CT10	37 38 39

# ELEMENTI DI STAFFAGGIO/CLAMPING TOOLS

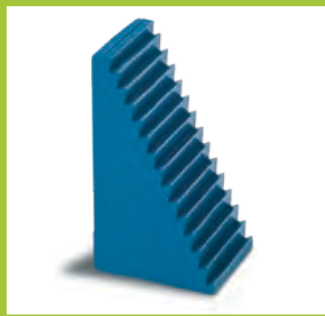

# S110

NR. 6500E

APPOGGI DENTATI  
TOOTHED SUPPORTS

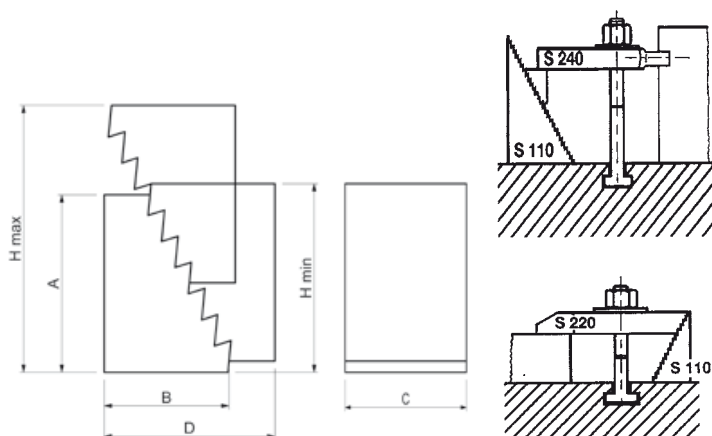
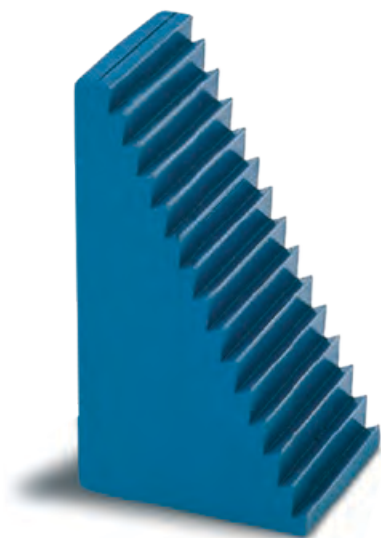

Materiale: Acciaio da bonifica verniciato  
Altezza gradino:  
verticale 4,65 mm - orizzontale 2,3 mm.

Material: Hardening painted steel  
Height of tooth:  
vertical 4,65 mm - horizontal 2,3 mm.

Code	Model S110	A	B	C	D	H min	H max	 gr
5034984	00001	31,5	22	30	38	31,5	53	90
5034985	00002	64,5	36,5	30	70	64,5	105	300
5034986	00003	128	68	30	132	128	208	1050

Si eseguono su richiesta misure non a catalogo / Other sizes can be supplied on request.

# S120

NR. 6400

APPOGGI A VITE  
SCREW SUPPORTS



N.B: S120.00050 senza foro

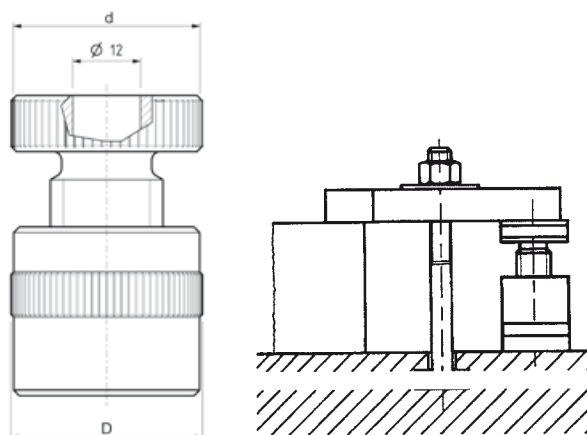

Materiale: Acciaio da bonifica verniciato.

Material: Hardening painted steel.

Code	Model S120	H min	H max	d	D	F max kN	gr	Passo
5034990	00050	40	50	34	34	20	190	M20
5034991	00070	54	70	50	50	60	620	M30
5034993	00100	73	100	50	50	60	900	M30
5034995	00140	100	140	65	70	105	2600	Q40x6
5034996	00210	140	210	70	80	180	4900	Q50x6
5034998	00300	190	300	80	100	360	10500	Q65x6

Si eseguono su richiesta misure non a catalogo / Other sizes can be supplied on request.

# S121

NR. 6401

APPOGGI A VITE CON BASE IN ALLUMINIO  
SCREW SUPPORTS WITH ALUMINIUM BASE

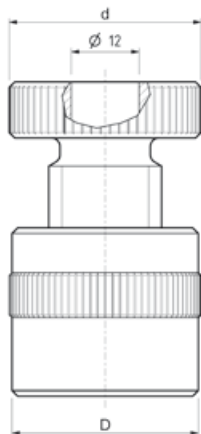

Possibilità di posizionamento e registrazione sia in verticale che in orizzontale.

Base - materiale: Lega in alluminio "ERGAL" EN 7075

Base - material: "ERGAL" aluminium alloy EN 7075

Code	Model S121	H min	H max	d	D	F max kN	
5035001	00050	45	55	50	50	30	370
5035003	00070	55	70	50	50	30	430
5035004	00100	73	103	50	50	30	600

Si eseguono su richiesta misure non a catalogo / Other sizes can be supplied on request.

# S122

NR. 6405

APPOGGI A VITE CON BASE MAGNETICA  
SCREW SUPPORTS WITH MAGNETIC BASE

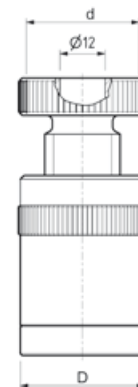

Possibilità di posizionamento e registrazione sia in verticale che in orizzontale.

Base - materiale: Lega in alluminio "ERGAL" EN 7075

The magnetic base allows this item to be used as an adjustable vertical or horizontal support.

Base - material: "ERGAL" aluminium alloy EN 7075

Code	Model S122	H min	H max	d	D	F max kN	
5035006	00050	57	67	50	50	30	380
5035007	00070	67	82	50	50	30	550
5035008	00100	85	115	50	50	30	710

Si eseguono su richiesta misure non a catalogo / Other sizes can be supplied on request.

# S125

**PROLUNGHE PER APPOGGI A VITE**  
EXTENSION PIECES FOR SCREW SUPPORTS

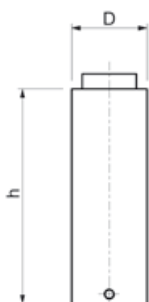

Utilizzato con l'articolo S120 permette di prolungare l'altezza dell'appoggio. Materiale: acciaio da bonifica verniciato. Possono essere sovrapposte.

Used with S120 give possibility to extend the length of the support. Material: Hardening painted steel. They should be placed one upon another.

Code	Model S125	D	h	Per articolo S120	 gr
5035011	35025	35	25	00050	120
5035012	35050	35	50	00050	230
5035013	35075	35	75	00050	360
5035014	35100	35	100	00050	480
5035017	50050	50	50	00070/100	480
5035019	50075	50	75	00070/100	730
5035021	50100	50	100	00070/100	960
5035022	50150	50	150	00070/100	1450
5035023	70050	70	50	00140	1210
5035024	70100	70	100	00140	2400
5035025	70150	70	150	00140	3600
5035026	70200	70	200	00140	4800

Si eseguono su richiesta misure non a catalogo / Other sizes can be supplied on request.

# S151

NR. 6440

**PUNTALI BOMBATI**  
CONVEX CAPS

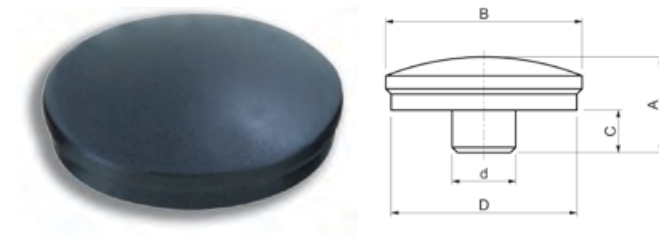

Utilizzati su S120-S121-S122-S130-S131.  
Materiale: acciaio da bonifica brunito.

Used on article S120-S121-S122-S130-S131.  
Material: Hardening blacked steel.

Code	Model S151	A	B	C	D	d	gr
5035041	00035	18	37	8	35	12	70

# S152

NR. 6441

**PUNTALI PRISMATICI**  
"V" GROOVE CAPS



Utilizzati su S120-S121-S122-S130-S131.  
Materiale: acciaio da bonifica brunito.

Used on article S120-S121-S122-S130-S131.  
Material: Hardening blacked steel

Code	Model S152	A	B	C	D	d	 gr
5035042	00045	23	32	8	45	12	145
5035043	00065	38	56	8	65	12	580

Si eseguono su richiesta misure non a catalogo / Other sizes can be supplied on request.

# S130

NR. 6430

APPOGGI A VITE "ATLAS"  
SCREW SUPPORTS "ATLAS" TYPE



S130.18140  
S130.18200

S130.22320  
S130.22550

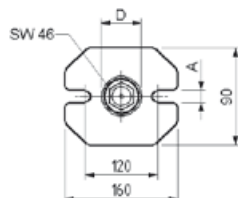
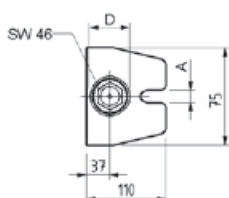

Filettatura trapezoidale passo 30x6.  
Con vite di fermo.  
Materiale: acciaio da bonifica verniciato.

Trapezoidal thread 30x6.  
With stationary screw.  
Material: Hardening painted steel.

Code	Model S130	H min	H max	A	D	F max kN	
5035028	18140	100	140	18	50	60	1800
5035029	18200	140	200	18	50	60	2300
5035031	22320	200	320	22	50	40	3600
5035032	22550	320	550	22	50	25	5500

Si eseguono su richiesta misure non a catalogo / Other sizes can be supplied on request.

# S131

NR. 6435

APPOGGI A VITE TIPO PESANTE  
SCREW SUPPORTS HEAVY TYPE

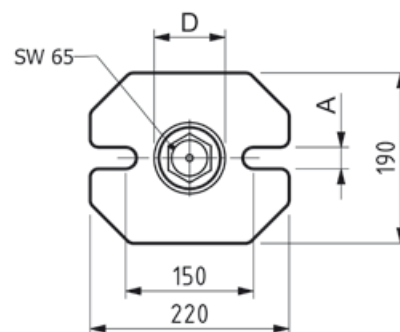

Filettatura trapezoidale passo 40x6.  
Materiale: acciaio da bonifica verniciato.

Trapezoidal thread 40x6. Material: Hardening painted steel.

Code	Model S131	H min	H max	A	D	F max kN	
5035033	00300	200	300	26	70	80	9500
5035034	00460	280	460	26	70	60	11000
5035035	00750	430	750	26	70	50	13500
5035036	01250	710	1250	26	70	45	19000

Si eseguono su richiesta misure non a catalogo / Other sizes can be supplied on request.



# S210

DIN 6314

## STAFFE SEMPLICI STANDARD CLAMPS

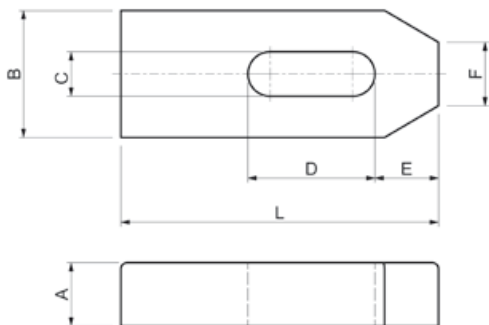

Code	Model S210	A	B	L	C	D	E	F		
5035046	07050	10	20	50	7	20	10	8	6	65
5035047	09060	12	25	60	9	22	13	10	8	115
5035048	11080	15	30	80	11	30	15	12	10	225
5035049	14100	20	40	100	14	40	21	14	12-14	500
5035050	14125	20	40	125	14	50	21	14	12-14	620
5035051	14160	20	40	160	14	65	21	14	12-14	815
5035052	18125	25	50	125	18	45	26	18	16-18	980
5035053	18160	25	50	160	18	65	26	18	16-18	1260
5035054	18200	25	50	200	18	80	26	18	16-18	1600
5035055	22160	30	60	160	22	60	30	22	20-22	1850
5035056	22200	30	60	200	22	80	30	22	20-22	2300
5035058	26200	30	70	200	26	80	35	26	24	2650
5035059	26250	30	70	250	26	105	35	26	24	3300
5035060	34250	40	80	250	34	100	45	34	27-30	5000
5035061	34315	40	80	315	34	130	45	34	27-30	6200

Si eseguono su richiesta misure non a catalogo / Other sizes can be supplied on request.

Materiale: Acciaio da bonifica verniciato  
R. > 700 N/mm<sup>2</sup>.

Material: Hardening painted steel  
R. > 700 N/mm<sup>2</sup>.

# S211

## STAFFE SEMPLICI RIDOTTE SHAPED STANDARD CLAMPS

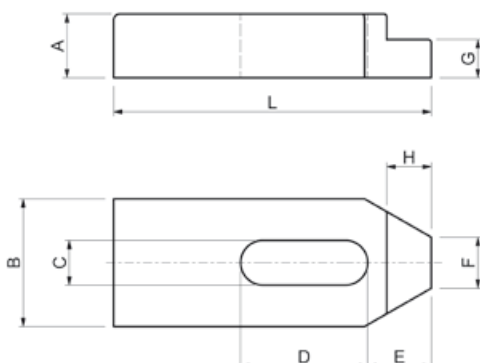
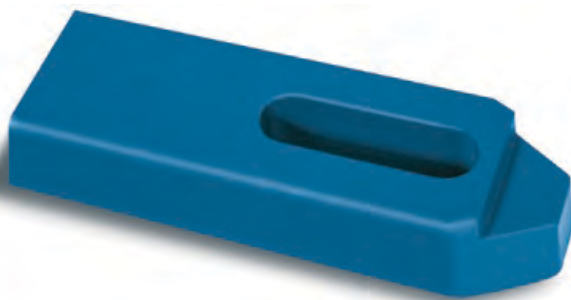

Code	Model S211	G	A	B	L	C	D	E	F	H		
5035062	07050	6	10	20	50	7	20	10	8	7	6	60
5035063	09060	7	12	25	60	9	22	13	10	10	8	140
5035064	11080	9	15	30	80	11	30	15	12	9	10	220
5035065	14100	12	20	40	100	14	40	21	14	12	12-14	480
5035066	14125	12	20	40	125	14	50	21	14	12	12-14	615
5035067	14160	12	20	40	160	14	65	26	14	12	12-14	800
5035068	18125	15	25	50	125	18	45	26	18	15	16-18	960
5035069	18160	15	25	50	160	18	65	26	18	15	16-18	1230
5035070	18200	15	25	50	200	18	80	26	18	15	16-18	1550
5035072	22160	20	30	60	160	22	60	30	22	20	20-22	1800
5035073	22200	20	30	60	200	22	80	30	22	20	20-22	2200
5035075	26200	20	30	70	200	26	80	35	26	25	24	2450
5035076	26250	20	30	70	250	26	105	35	26	25	24	3200
5035077	34250	25	40	80	250	34	100	45	34	25	27-30	4800
5035078	34315	25	40	80	315	34	130	45	34	25	27-30	6000

Si eseguono su richiesta misure non a catalogo / Other sizes can be supplied on request.

Materiale: Acciaio da bonifica verniciato  
R. > 700 N/mm<sup>2</sup>.

Material: Hardening painted steel  
R. > 700 N/mm<sup>2</sup>.

# S220

NR. 6314Z

## STAFFE DENTATE TOOTHED CLAMPS

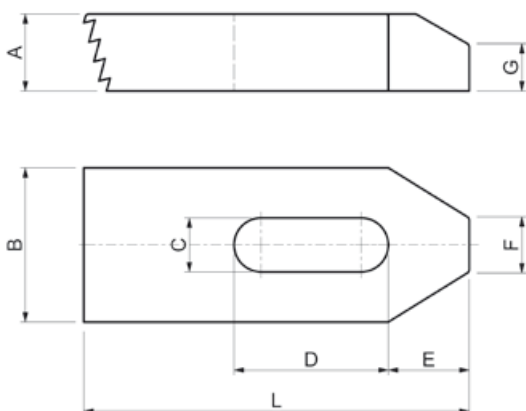

Code	Model S220	A	B	L	C	D	E	F	G		gr
5035084	07050	10	20	50	7	20	10	8	6	6	55
5035085	09060	12	25	60	9	22	13	10	8	8	125
5035086	11080	15	30	80	11	30	15	12	10	10	205
5035087	14100	20	40	100	14	40	21	14	12	12-14	445
5035088	18125	25	50	125	18	45	26	18	15	16-18	930
5035089	22160	30	60	160	22	60	30	22	18	20-22	1700
5035090	26200	30	70	200	26	80	35	26	18	24	2500

Si eseguono su richiesta misure non a catalogo / Other sizes can be supplied on request.

Materiale: Acciaio da bonifica verniciato  
R. > 700 N/mm<sup>2</sup>.

Material: Hardening painted steel  
R. > 700 N/mm<sup>2</sup>.

# S230

NR. 6314V

## STAFFE REGOLABILI CON VITE FILETTATURA METRICA PASSO STANDARD ADJUSTABLE CLAMPS WITH METRIC STANDARD PITCH SCREW

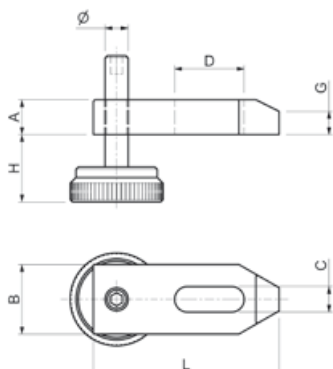

Code	Model S230	A	B	L	H	C	D	Ø	G		gr
5035094	11080	15	30	80	15-45	11	30	M10	10	10	345
5035097	14100	20	40	100	15-40	14	40	M12	12	12-14	680
5035099	18125	25	50	125	15-45	18	45	M16	15	16-18	1185
5035100	22160	30	60	160	15-50	22	60	M20	18	20-22	2030

Si eseguono su richiesta misure non a catalogo / Other sizes can be supplied on request.

Materiale: Acciaio da bonifica verniciato  
R. > 700 N/mm<sup>2</sup>.

Material: Hardening painted steel  
R. > 700 N/mm<sup>2</sup>.

### VITI RICAMBIO (SPARE SCREWS)

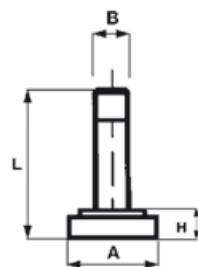

Code	Model S230	A	B	L	H		gr
5035101	00010	40	M10	60	15	150	
5035102	00012	45	M12	60	15	210	
5035103	00016	45	M16	70	15	245	
5035104	00020	45	M20	80	15	300	

Si eseguono su richiesta misure non a catalogo / Other sizes can be supplied on request.

# S240

DIN 6315C

STAFFE A FORCELLA CON GAMBO CILINDRICO  
FORKED CLAMPS WITH CYLINDRICAL SHANK

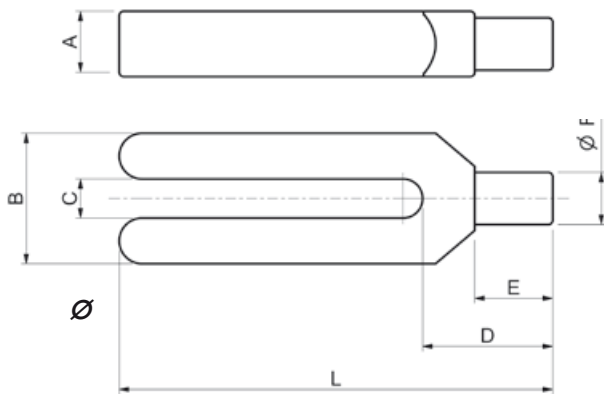

Materiale: Acciaio da bonifica verniciato  
R. > 600 N/mm<sup>2</sup>.

Material: Hardening painted steel  
R. > 600 N/mm<sup>2</sup>.

Code	Model S240	A	B	L	C	D	E	F		
5035105	09100	15	30	100	9	30	18	12	8	205
5035106	11125	20	30	125	11	36	24	16	10	335
5035107	14160	25	40	160	14	45	30	20	12-14	720
5035108	14200	25	40	200	14	45	30	20	12-14	920
5035109	18200	30	50	200	18	55	36	24	16-18	1310
5035110	18250	30	50	250	18	55	36	24	16-18	1640
5035111	22250	40	60	250	22	65	45	30	20-22	2610
5035112	22315	40	60	315	22	65	45	30	20-22	3300
5035113	26250	40	70	250	26	80	56	38	24	3100
5035114	26315	40	70	315	26	80	56	38	24	3900
5035116	34315	50	80	315	34	85	56	45	27-30	5500
5035117	34400	50	80	400	34	85	56	45	27-30	6900

Si eseguono su richiesta misure non a catalogo / Other sizes can be supplied on request.

# S250

NR. 6315GN

STAFFE A FORCELLA CON NASELLO  
FORKED CLAMPS WITH NIB

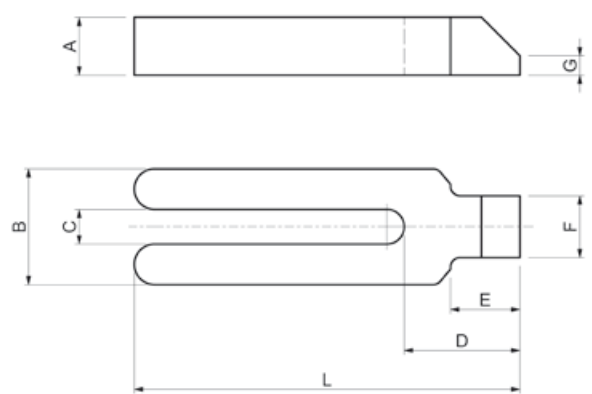

Materiale: Acciaio da bonifica verniciato  
R. > 600 N/mm<sup>2</sup>.

Material: Hardening painted steel  
R. > 600 N/mm<sup>2</sup>.

Code	Model S250	A	B	L	C	D	E	F	G		
5035118	09100	15	30	100	9	32	18	16	5	8	225
5035119	11125	20	30	125	11	38	24	20	6	10	360
5035120	14160	25	40	160	14	47	30	25	7	12-14	770
5035121	14200	25	40	200	14	47	30	25	7	12-14	950
5035122	18200	30	50	200	18	57	36	28	8	16-18	1420
5035123	18250	30	50	250	18	57	36	28	8	16-18	1700
5035124	22250	40	60	250	22	68	45	35	10	20-22	2790
5035125	22315	40	60	315	22	68	45	35	10	20-22	3480
5035127	26250	40	70	250	26	83	56	43	10	24	3320
5035128	26315	40	70	315	26	83	56	43	10	24	4270
5035129	34315	50	80	315	34	88	56	50	12	27-30	5700
5035130	34400	50	80	400	34	88	56	50	12	27-30	7250

Si eseguono su richiesta misure non a catalogo / Other sizes can be supplied on request.

# S260

DIN 6316

STAFFE A GOMITO  
CRANKED CLAMPS

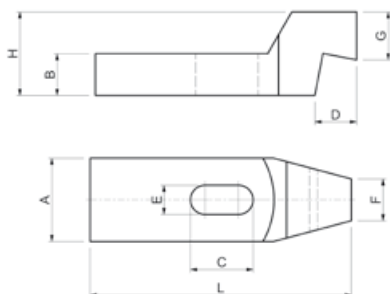

Il pregio dell'articolo sta nell'essere prodotto tramite la fresatura di un blocco d'acciaio (non è quindi piegato).

Material: acciaio da bonifica verniciato R. > 700 N/mm<sup>2</sup>.

This article is produced milling a steel block (it is not produced by bending).

Material: Hardening painted steel R. > 700 N/mm<sup>2</sup>.

Code	Model S260	A	B	L	C	E	D	F	G	H		
5035133	14125	40	20	125	30	14	20	20	23	40	12-14	750
5035135	18160	50	25	160	40	18	25	25	28	50	16-18	1510
5035136	18200	50	25	200	60	18	25	25	28	50	16-18	1790
5035137	22160	60	30	160	40	22	30	30	35	60	20-22	2190
5035138	22200	60	30	200	60	22	30	30	35	60	20-22	2700
5035139	26200	70	35	200	50	26	35	35	38	70	24	3660
5035140	26250	70	35	250	75	26	35	35	38	70	24	4560

Si eseguono su richiesta misure non a catalogo / Other sizes can be supplied on request.

# S270

DIN 6315B

STAFFE A FORCELLA CON SMUSSO  
FORKED CLAMPS WITH BEVEL

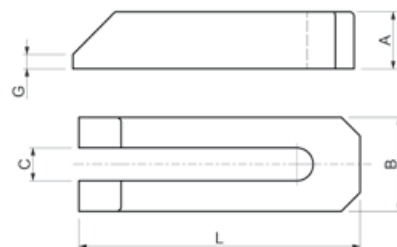
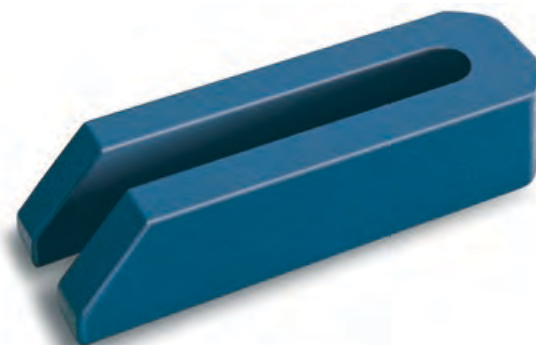

Il pregio dell'articolo sta nell'essere prodotto tramite la fresatura di un blocco d'acciaio (non è quindi piegato).

Material: acciaio da bonifica verniciato R. > 600 N/mm<sup>2</sup>.

This article is produced milling a steel block (it is not produced by bending).

Material: Hardening painted steel R. > 600 N/mm<sup>2</sup>.

Code	Model S270	A	B	L	C	G		
5035143	07060	12	20	60	7	3	6	70
5035144	09080	15	25	80	9	4	8	150
5035146	11100	20	30	100	11	5	10	270
5035147	14125	25	40	125	14	6	12-14	590
5035149	14160	25	40	160	14	6	12-14	760
5035150	14200	25	40	200	14	6	12-14	970
5035151	18160	30	50	160	18	8	16-18	1160
5035152	18200	30	50	200	18	8	16-18	1400
5035153	18250	40	50	250	18	10	16-18	2330
5035154	22200	40	50	200	22	10	20-22	1700
5035155	22250	40	60	250	22	10	20-22	2880
5035156	22315	40	60	315	22	10	20-22	3530
5035158	26200	40	70	200	26	10	24	2680
5035159	26250	40	70	250	26	10	24	3370
5035160	26315	40	70	315	26	10	24	4220
5035161	34250	50	80	250	34	12	27-30	4480
5035162	34315	50	80	315	34	12	27-30	5600
5035163	34400	50	80	400	34	12	27-30	7150
5035164	40400	60	100	400	40	12	36	11700
5035165	40600	60	100	600	40	12	36	17300

Si eseguono su richiesta misure non a catalogo / Other sizes can be supplied on request.

# S280

NR. 6314AV

STAFFE REGOLABILI CON VITE PASSO QUADRO  
ADJUSTABLE CLAMPS WITH SQUARE THREAD  
SCREW

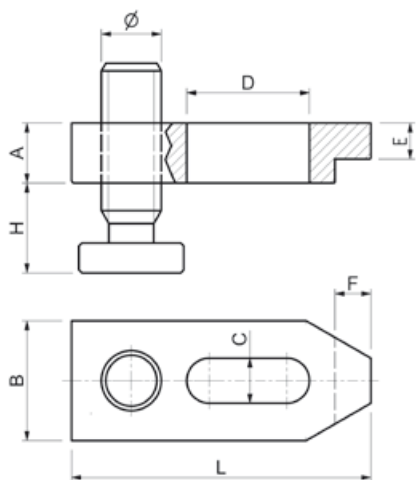

Materiale: Acciaio da bonifica verniciato  
R. > 700 N/mm<sup>2</sup>.

Material: Hardening painted steel  
R. > 700 N/mm<sup>2</sup>.

Code	Model S280	A	B	L	H	C	D	Ø	E	F		
5035166	14100	20	40	100	15-50	15	40	20x4	12	12	12-14	620
5035168	14125	20	40	125	15-50	15	45	20x4	12	12	12-14	770
5035170	14160	20	40	160	15-50	15	60	20x4	12	12	12-14	950
5035172	18125	25	50	125	15-45	19	45	20x4	15	15	16-18	1090
5035175	18160	25	50	160	15-75	19	60	30x6	15	15	16-18	1650
5035176	18200	25	50	200	15-75	19	80	30x6	15	15	16-18	1970
5035178	22160	30	60	160	15-70	23	60	30x6	15	20	20-22	2120
5035180	22200	30	60	200	15-70	23	80	30x6	15	20	20-22	2570
5035183	26200	40	70	200	15-85	27	80	30x6	25	23	24	4080
5035186	26250	40	70	250	15-85	27	100	30x6	25	23	24	5000
5035188	26300	40	70	300	15-85	27	100	30x6	25	23	24	6080

Si eseguono su richiesta misure non a catalogo / Other sizes can be supplied on request.

# S281

NR. 6315GN

VITI DI RICAMBIO PER STAFFE  
SPARE SCREWS FOR CLAMPS

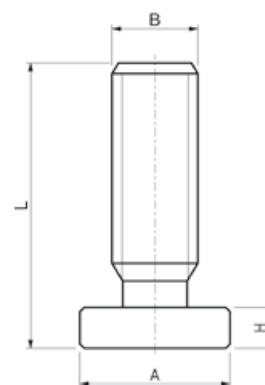

Filetto TPN passo quadro.  
Materiale: Acciaio automatico da bonifica

TPN thread square pitch  
Material: Automatic alloy steel

Code	Model S281	A	B	L	H	
5035192	20004	35	20x4	70	10	185
5035192	20004	35	20x4	70	10	185
5035192	20004	35	20x4	70	10	185
5035192	20004	35	20x4	70	10	185
5035193	30006	45	30x6	100	15	540
5035193	30006	45	30x6	100	15	540
5035193	30006	45	30x6	100	15	540
5035193	30006	45	30x6	100	15	540
5035194	30006.A	70	30x6	125	15	905
5035194	30006.A	70	30x6	125	15	905
5035194	30006.A	70	30x6	125	15	905

Si eseguono su richiesta misure non a catalogo / Other sizes can be supplied on request.

# ML10

NR. 6490

## MORSETTI LATERALI SIDE BUCKLES

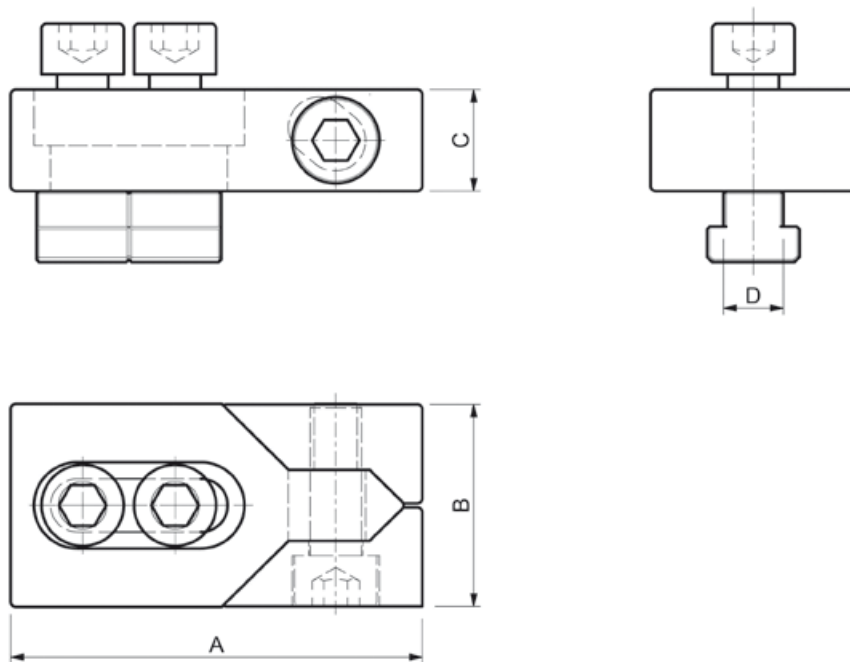
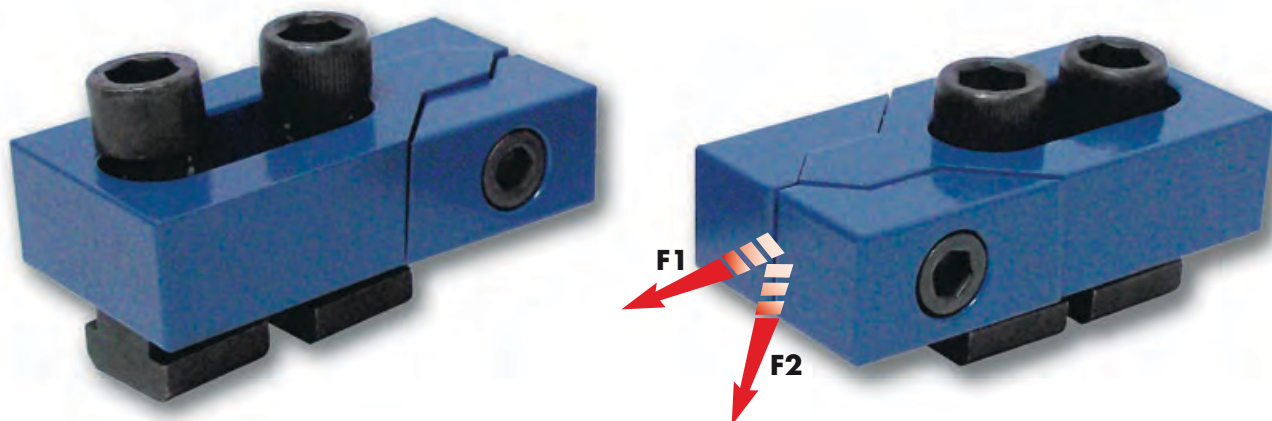

Materiale: acciaio da bonifica verniciato.  
Costruzione a cuneo che permette il bloccaggio contemporaneo del pezzo in senso verticale ed orizzontale. Forniti in coppia.

Material: hardening painted steel. Wedge type construction which enable to simultaneously clamp vertically and horizontally. Supplied in pairs.

Code	Model ML10	A	B	C	D		kN F1	kN F2	
5032213	00012	80	40	20	11,7	12	16	0,6	1,040
5032214	00014	80	40	20	13,7	14	22	0,9	1,070
5032215	00016	100	50	25	15,7	16	32	1,2	2,040
5032216	00018	100	50	25	17,7	18	36	1,4	2,080
5032217	00020	100	50	25	19,7	20	36	1,4	2,290
5032218	00022	140	78	30	21,7	22	36	1,4	5,530
5032219	00024	140	78	30	23,7	24	36	1,4	5,800
5032220	00028	140	78	30	27,7	28	40	1,6	6,200
5032221	00030	140	78	30	29,7	30	40	1,6	6,800

Si eseguono su richiesta misure non a catalogo / Other sizes can be supplied on request.

# S410

## STAFFAGGI ASSORTITI ASSORTED CLAMPING TOOLS

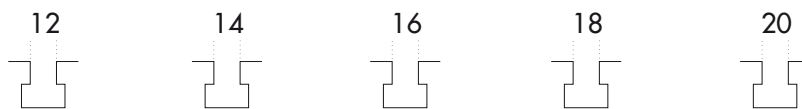

Code	5036048	5036049	5036050	5036051	5036052	
Model	S410.00012	S410.00014	S410.00016	S410.00018	S410.00020	
Descrizione	Compos.	Compos.	Compos.	Compos.	Compos.	Description
Appoggi dentati	S110.00001 2	S110.00001 2	S110.00001 2	S110.00001 2	S110.00001 2	Toothed supports
Appoggi dentati	S110.00002 4	S110.00002 4	S110.00002 4	S110.00002 4	S110.00002 4	Toothed supports
Appoggi dentati	S110.00003 2	S110.00003 2	S110.00003 2	S110.00003 2	S110.00003 2	Toothed supports
Staffe semplici	S210.14100 4	S210.14125 4	S210.18125 4	S210.18125 4	S210.22200 4	Flat clamps
Staffe dentate	S220.14100 4	S220.14100 4	S220.18125 4	S220.18125 4	S220.22160 4	Toothed clamps
Viti testa martello	S310.12080 2	S310.14100 2	S310.16100 4	S310.18150 4	S310.20150 4	T-slot bolts
Viti testa martello	S310.12125 4	S310.14150 4	S310.16150 2	S310.18200 2	S310.20200 2	T-slot bolts
Prigionieri completi	S320.10080 2	S320.12080 2	S320.14100 2	S320.16125 2	S320.18125 2	Studs
Prigionieri completi	S320.10100 2	S320.12160 2	S320.14160 2	S320.16160 2	S320.18160 2	Studs
Dadi prolung.	S350.10030 4	S350.12036 4	S350.14042 4	S350.16048 4	S350.18054 4	Extensions nuts
Dadi alti	S340.12018 6	S340.14021 6	S340.16024 6	S340.18027 6	S340.20030 6	Turned toll nuts
Tasselli per cave	S360.10012 4	S360.12014 4	S360.14016 4	S360.16018 4	S360.18020 4	T-slot nuts
Rondelle	S370.00012 6	S370.00014 6	S370.00016 6	S370.00018 6	S370.00020 6	Washers
Peso kg	10,5	12	17	18	27	Weight kg.
Code	5036054		5036055		5036056	
Model	S410.BOX01		S410.BOX02		S410.BOX03	
Cassetta in legno vuota						Wooden box
Dimensioni	cm. 37x32		cm. 47x33		cm. 50x41	Sizes

Si eseguono su richiesta misure non a catalogo / Other sizes can be supplied on request.

# S440

APPOGGI DENTATI ASSORTITI

ASSORTED TOOTHED SUPPORT BLOCKS



Code	5036079
Model	S440.00001
COMPOS.	
S110.00001	8
S110.00002	8
S110.00003	4
Peso/Weight	Kg 8,5
dim.	cm 30,5x17

Si eseguono su richiesta misure non a catalogo / Other sizes can be supplied on request.



# BULLONERIA VARIA/ NUTS AND BOLTS



# BF10

BARRE FILETTATE  
THREADED BARS



# BF20

BARRE FILETTATE INOX  
STAINLESS STEEL THREADED BARS



Su richiesta anche sinistre  
On request also left-hand threaded

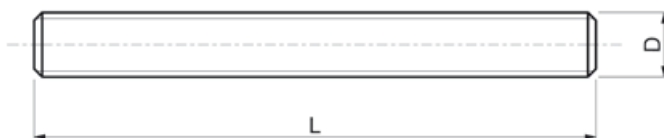

Materiale: 42CrMoS4 Classe 10.9  
Filetto ottenuto per rullatura.

Material: 42CrMoS4 Class 10.9  
Rolled thread.

Code	Model BF10	D	L	kg
5027705	00006	M6	1000	0,200
5027707	00008	M8	1000	0,350
5027708	00010	M10	1000	0,550
5027709	00012	M12	1000	0,800
5027710	00014	M14	1000	1,000
5027711	00016	M16	1000	1,300
5027712	00018	M18	1000	1,600
5027713	00020	M20	1000	2,100
5027717	00022	M22	1000	2,600
5027718	00024	M24	1000	3,000
5027720	00027	M27	1000	3,900
5027721	00030	M30	1000	5,000
5027722	00033	M33	1000	6,000
5027723	00036	M36	1000	6,900
5027727	00042	M42	1000	9,300
5027729	00048	M48	1000	12,200

Si eseguono su richiesta misure non a catalogo / Other sizes can be supplied on request.

Materiale: acciaio inox AISI 304 Classe A2  
Filetto ottenuto per rullatura.

Material: stainless steel AISI 304 Class A2.  
Rolled thread.

Code	Model BF20	D	L	kg
5027746	00006	M6	1000	0,200
5027750	00008	M8	1000	0,350
5027757	00010	M10	1000	0,550
5027758	00012	M12	1000	0,800
5027759	00014	M14	1000	1,000
5027760	00016	M16	1000	1,300
5027761	00018	M18	1000	1,600
5027762	00020	M20	1000	2,100
5027763	00022	M22	1000	2,600
5027764	00024	M24	1000	3,000
5043097	00027	M27	1000	3,900
5027765	00030	M30	1000	5,000
5027766	00036	M36	1000	6,900

Si eseguono su richiesta misure non a catalogo / Other sizes can be supplied on request.

Su richiesta è disponibile la fornitura dell'attestato di controllo 2.2. / On demand it is available the supply of certificates 2.2.

# S310

## VITI TESTA A MARTELLLO COMPLETE DI DADO S340 E RONDELLA S370 HAMMERHEAD BOLTS COMPLETE WITH NUT S340 AND WASHER S370

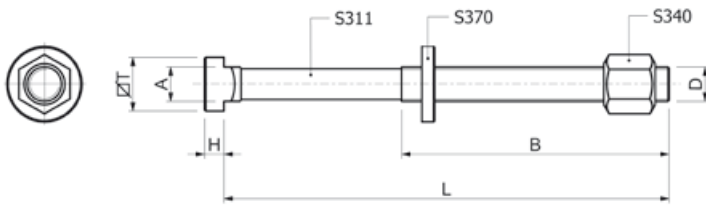

Materiale: 42CrMoS4 Classe 10.9. Filetto ottenuto per rullatura

Material: 42CrMoS4 Class 10.9. Rolled thread

Code	Model S310	D	L	B	A	T	H		
5035206	10040	M10	40	30	9,7	15	6	10	60
5035208	10060		63	45					80
5035209	10080		80	55					85
5035210	10100		100	60					100
5035211	10125		125	75					105
5035212	10150		150	100					120
5035213	10170		170	100					130
5035214	12050	M12	50	35	11,7	18	7	12	110
5035215	12060		63	45					115
5035217	12080		80	55					125
5035218	12100		100	60					140
5035219	12125		125	75					150
5035220	12150		150	100					180
5035222	12170		170	100					195
5035223	12200		200	120					210
5035224	14060	M14	63	40	13,7	22	8	14	160
5035225	14080		80	55					180
5035226	14100		100	65					215
5035227	14125		125	75					240
5035228	14150		150	100					270
5035229	14170		170	100					290
5035230	14200		200	125					315
5035231	14230		230	150					345
5035232	16060	M16	63	45	15,7	25	9	16	230
5035233	16080		80	55					250
5035234	16100		100	63					270
5035235	16125		125	75					315
5035236	16150		150	100					345
5035237	16160		160	100					360
5035238	16170		170	100					370
5035239	16200		200	125					405
5035240	16230		230	150					450
5035241	16250		250	150					470

Code	Model S310	D	L	B	A	T	H		
5035242	18080	M18	80	55	17,7	28	10	18	315
5035243	18100		100	65					335
5035244	18125		125	85					410
5035245	18150		150	100					450
5035246	18170		170	100					480
5035247	18200		200	125					530
5035248	18230		230	150					560
5035249	20080	M20	80	55	19,7	32	12	20	440
5035250	20100		100	63					490
5035251	20125		125	85					540
5035252	20150		150	100					600
5035253	20160		160	110					620
5035254	20170		170	100					625
5035255	20200		200	125					700
5035256	20230		230	150					820
5035257	20315		315	190					950
5035258	22080	M22	80	55	21,7	35	14	22	540
5035259	22100		100	63					580
5035260	22125		125	85					630
5035261	22150		150	100					710
5035262	22170		170	100					790
5035263	22200		200	125					870
5035264	22230		230	150					890
5035265	24080	M24	80	55	23,7	40	16	24	720
5035266	24100		100	70					810
5035267	24125		125	85					870
5035268	24150		150	100					980
5035269	24160		160	110					1010
5035270	24170		170	100					1040
5035271	24200		200	125					1170
5035272	24230		230	150					1220
5035273	24250		250	150					1230
5035274	27160	M27	160	110	27,7	44	18	28	1170
5035275	27200		200	125					1320
5035276	27250		250	150					1490
5035277	27315		315	240					1860

Si eseguono su richiesta misure non a catalogo / Other sizes can be supplied on request.

Si eseguono su richiesta misure non a catalogo / Other sizes can be supplied on request.

Su richiesta è disponibile la fornitura dell'attestato di controllo 2.2. / On demand it is available the supply of certificates 2.2.

# S311

## VITI TESTA A MARTELLLO SINGOLE SINGLE HAMMERHEAD BOLTS

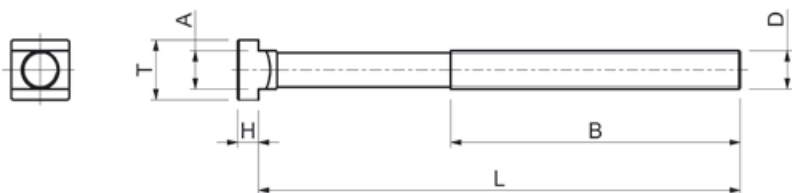

Materiale: 42CrMoS4 Classe 10.9 Filetto ottenuto per rullatura

Material: 42CrMoS4 Class 10.9 Rolled thread

Code	Model S311	D	L	B	A	T	H		
5035283	10040	M10	40	30	9,7	15	6	10	30
5035286	10060		63	45					50
5035287	10080*		80	55					55
5035288	10100		100	60					70
5035289	10125*		125	75					75
5035290	10150*		150	100					90
5035291	10170*		170	100					100
5035294	12050	M12	50	35	11,7	18	7	12	60
5035295	12060*		63	45					65
5035297	12080		80	55					75
5035298	12100*		100	60					90
5035299	12125		125	75					110
5035300	12150*		150	100					130
5035302	12170*		170	100					145
5035303	12200		200	120					160
5035307	14060*	M14	63	40	13,7	22	8	14	80
5035309	14080*		80	55					100
5035310	14100*		100	65					135
5035311	14125*		125	75					160
5035313	14150*		150	100					190
5035314	14170*		170	100					210
5035315	14200*		200	125					235
5035316	14230*		230	150					265
5035319	16060*	M16	63	45	15,7	25	9	16	140
5035321	16080*		80	55					160
5035323	16100*		100	63					180
5035324	16125*		125	75					225
5035325	16150*		150	100					255
5035326	16160*		160	100					270
5035327	16170*		170	100					280
5035328	16200*		200	125					315
5035329	16230*		230	150					360
5035330	16250*		250	150					380

Code	Model S311	D	L	B	A	T	H		
5035333	18080*	M18	80	55	17,7	28	10	18	185
5035334	18100*		100	65					203
5035335	18125*		125	85					280
5035336	18150*		150	100					320
5035337	18170*		170	100					350
5035338	18200*		200	125					400
5035339	18230*		230	150					430
5035340	20080*	M20	80	55	19,7	32	12	20	290
5035341	20100*		100	63					340
5035342	20125*		125	85					390
5035343	20150*		150	100					450
5035344	20160*		160	110					470
5035345	20170*		170	100					475
5035346	20200*		200	125					550
5035347	20230*		230	150					670
5035348	20315*		315	190					800
5035349	22080*	M22	80	55	21,7	35	14	22	330
5035350	22100*		100	63					370
5035351	22125*		125	85					430
5035352	22150*		150	100					500
5035353	22170*		170	100					590
5035354	22200*		200	125					660
5035355	22230*		230	150					680
5035356	24080*	M24	80	55	23,7	40	16	24	450
5035357	24100*		100	70					550
5035358	24125*		125	85					600
5035359	24150*		150	100					710
5035360	24160*		160	110					740
5035361	24170*		170	100					770
5035362	24200*		200	125					900
5035364	24230*		230	150					935
5035365	24250*		250	150					995
5035367	27160*	M27	160	110	27,7	44	18	28	800
5035368	27200*		200	125					950
5035369	27250*		250	150					1120
5035370	27315*		315	240					1490

Si eseguono su richiesta misure non a catalogo / Other sizes can be supplied on request.

Si eseguono su richiesta misure non a catalogo / Other sizes can be supplied on request.

Su richiesta è disponibile la fornitura dell'attestato di controllo 2.2. / On demand it is available the supply of certificates 2.2.

\* Misura non inclusa nella norma DIN 787 / Size not included in the DIN 787 standard

# S312

## VITI TESTA A MARTELLLO SINGOLE TESTA MAGGIORATA SINGLE HAMMERHEAD BOLTS INCREASED HEAD

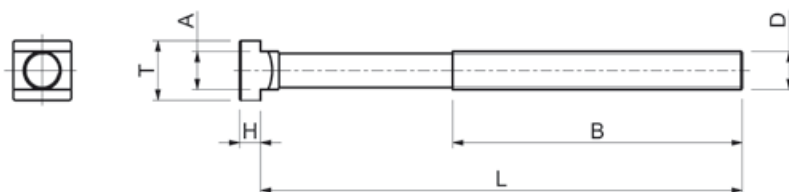



Materiale: 42CrMoS4 Classe 10.9. Filetto ottenuto per rullatura

Code	Model S312	D	L	B	A	T	H		
5035371	16090	M16	93	55	15,7	28	12	16	170
5035372	16120		120	75					220
5035373	16150		150	100					255
5035374	16200		200	125					315
5035375	16225		225	160					355
5035376	16250		250	160					380
5035377	16300		300	180					460

Si eseguono su richiesta misure non a catalogo / Other sizes can be supplied on request.

Material: 42CrMoS4 Class 10.9. Rolled thread

Code	Model S312	D	L	B	A	T	H		
5035378	18120	M18	120	75	17,7	35	14	18	270
5035379	18150		150	100					320
5035380	18200		200	125					400
5035381	18225		225	150					420
5035382	18250		250	150					470
5035383	18300		300	190					565
5035384	20120	M20	120	75	19,7	40	16	20	375
5035385	20150		150	100					450
5035386	20200		200	125					550
5035387	20225		225	150					655
5035388	20250		250	150					730
5035389	20300		300	190					765
5035390	24120	M24	120	75	23,7	44	20	24	580
5035391	24150		150	100					710
5035393	24200		200	125					900
5035394	24225		225	150					915
5035395	24250		250	150					995
5035396	24300		300	190					1200

Si eseguono su richiesta misure non a catalogo / Other sizes can be supplied on request.

Su richiesta è disponibile la fornitura dell'attestato di controllo 2.2. / On demand it is available the supply of certificates 2.2.

# S315

## VITI TESTA A MARTELLO COMPLETE DI DADO S340 E RONDELLA S390

### HAMMERHEAD BOLTS COMPLETE WITH NUT S340 AND WASHER S390



#### Cava maggiorata

Materiale: 42CrMoS4 Classe 10.9. Filetto ottenuto per rullatura.

#### Increased slot

Material: 42CrMoS4 Class 10.9. Rolled thread.



Code	Model S315	D	L	B	A	T	H			gr
5035397	12050	M12	50	35	13,7	22	8	14		145
5035398	12063		63	45						150
5035399	12080		80	55						165
5035400	12100		100	65						175
5035401	12125		125	75						185
5035402	12160		160	100						225
5035403	12200		200	120						245
5035404	14063	M14	63	45	15,7	25	9	16		210
5035406	14100		100	63						245
5035408	14160		160	100						305
5035409	14230		230	150						370
5035411	16063	M16	63	45	17,7	28	10	18		290
5035412	16080		80	55						315
5035413	16100		100	63						335
5035414	16125		125	85						380
5035415	16160		160	100						410
5035416	16200		200	125						475
5035417	16230		230	150						520
5035418	16250		250	150						560
5035419	20080	M20	80	55	21,7	35	14	22		515
5035420	20100		100	63						565
5035421	20125		125	85						615
5035422	20160		160	110						675
5035423	20200		200	125						755
5035424	20230		230	150						830
5035425	20315		315	190						1010
5035426	24100	M24	100	70	27,7	44	18	28		1020
5035427	24125		125	85						1110
5035428	24160		160	110						1170
5035429	24200		200	125						1320
5035430	24230		230	150						1430
5035431	24250		250	150						1490
5035432	24315		315	190						1860
5035434	30125	M30	125	80	35,7	53	22	36		1860
5035435	30160		160	110						1940
5035436	30200		200	134						2120
5035437	30250		250	149						2360
5035438	30315		315	190						2670

Si eseguono su richiesta misure non a catalogo / Other sizes can be supplied on request.

Su richiesta è disponibile la fornitura dell'attestato di controllo 2.2. / On demand it is available the supply of certificates 2.2.

\* Misura non inclusa nella norma DIN 787 / Size not included in the DIN 787 standard

# S316

DIN 787

## VITI TESTA A MARTELLO SINGOLE SINGLE HAMMERHEAD BOLTS



#### Cava maggiorata

Materiale: 42CrMoS4 Classe 10.9. Filetto ottenuto per rullatura.

#### Increased slot

Material: 42CrMoS4 Class 10.9. Rolled thread.



Code	Model S316	D	L	B	A	T	H			gr
5035439	12050	M12	50	35	13,7	22	8	14		80
5035440	12063*		63	45						85
5035441	12080		80	55						100
5035442	12100*		100	65						110
5035443	12125		125	75						120
5035445	12160*		160	100						160
5035446	12200		200	120						180
5035447	14063*	M14	63	45	15,7	25	9	16		125
5035449	14100*		100	63						160
5035451	14160*		160	100						220
5035452	14230*		230	150						285
5035454	16063	M16	63	45	17,7	28	10	18		160
5035456	16080*		80	55						185
5035457	16100		100	63						205
5035458	16125*		125	85						250
5035459	16160		160	100						280
5035460	16200*		200	125						345
5035461	16230*		230	150						390
5035462	16250		250	150						430
5035464	20080	M20	80	55	21,7	35	14	22		330
5035465	20100*		100	63						380
5035466	20125		125	85						430
5035467	20160*		160	110						490
5035468	20200		200	125						570
5035469	20230*		230	150						645
5035471	20315		315	190						820
5035472	24100	M24	100	70	27,7	44	18	28		650
5035473	24125*		125	85						740
5035475	24160		160	110						800
5035476	24200*		200	125						950
5035477	24230*		230	150						1060
5035478	24250		250	150						1120
5035479	24315*		315	190						1490
5035481	30125	M30	125	80	35,7	53	22	36		1250
5035482	30160*		160	110						1300
5035483	30200		200	134						1480
5035484	30250*		250	149						1720
5035485	30315		315	190						2030

Si eseguono su richiesta misure non a catalogo / Other sizes can be supplied on request.

# S320

## PRIGIONIERI COMPLETI DI DADO S330 E RONDELLA S370 STUDS COMPLETE WITH SHORT NUT S330 AND WASHER S370

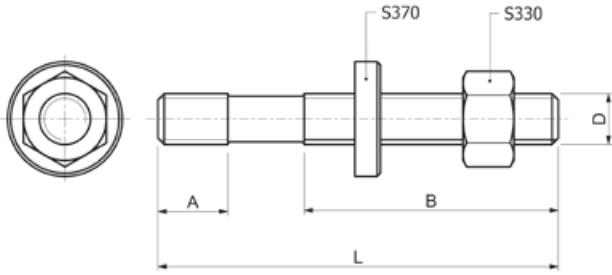

Materiale: 42CrMoS4 Classe 10.9. Filetto ottenuto per rullatura.  
Diametro medio sulla parte non filettata.

Material: 42CrMoS4 Class 10.9. Rolled thread.  
Average diameter on the non-threaded part.

Code	Model S320	D	L	A	B	gr
5035498	08040	M8	40	11	20	25
5035499	08060		63		40	35
5035500	08080		80		50	40
5035501	08100		100		63	45
5035502	08125		125		75	50
5035503	08160		160		100	60
5038467	08200		200		100	80
5035504	10050	M10	50	13	25	50
5035505	10060		63		35	55
5035506	10080		80		50	65
5035507	10100		100		75	75
5035508	10125		125		75	85
5035509	10160		160		100	105
5035510	10200		200		125	125
5035511	12050	M12	50	15	25	80
5035512	12060		63		32	85
5035513	12080		80		50	95
5035514	12100		100		63	110
5035515	12125		125		75	130
5035516	12160		160		100	155
5035517	12200		200		125	180
5035518	12225		225		160	205
5035519	12250		250		160	220
5035520	14060	M14	63	17	32	145
5035521	14080		80		50	150
5035522	14100		100		63	160
5035524	14125		125		75	190
5035525	14160		160		100	215
5035526	14200		200		125	260
5035527	14225		225		160	290
5035528	14250		250		160	305
5035529	16065	M16	63	19	35	160
5035530	16080		80		50	180
5035531	16100		100		63	205
5035532	16125		125		75	235
5035533	16160		160		100	295
5035534	16200		200		125	355
5035535	16225		225		160	370
5035536	16250		250		160	400
5035537	16315		315		180	500

Code	Model S320	D	L	A	B	gr
5043684	16350	M16	350	19	180	525
5043685	16400		400		250	575
5043686	16450		450		250	625
5043687	16500		500		315	675
5035538	18080	M18	80	23	50	230
5035539	18100		100		50	265
5035540	18125		125		75	300
5035541	18160		160		100	355
5035542	18200		200		125	420
5035543	18225		225		150	465
5035544	18250		250		150	500
5035545	18315		315		180	600
5043688	18400		400		250	745
5035546	20080	M20	80	27	30	305
5035547	20100		100		50	325
5035548	20125		125		70	375
5035549	20160		160		100	450
5035550	20200		200		125	530
5035551	20225		225		160	585
5035552	20250		250		160	630
5035553	20315		315		195	760
5035554	20350		350		195	842
5043085	20400		400		250	942
5043099	20450		450		250	1052
5035555	20500		500		315	1142
5035556	20600		600		315	1342
5043689	20650		650		315	1472
5043690	20700		700		400	1542
5043691	20800		800		400	1752
5043692	20900		900		400	1972
5035557	22100	M22	100	31	45	440
5035558	22120		120		63	470
5035559	22160		160		100	600
5035560	22200		200		125	670
5043078	22225		225		160	740
5035561	22250		250		160	840
5035562	22315		315		180	920
5043693	22350		350		195	1010
5043694	22400		400		250	1120
5043098	22500		500		315	1430

Code	Model S320	D	L	A	B	gr
5035563	24100	M24	100	35	45	490
5035564	24125		125		70	580
5035565	24160		160		100	670
5035566	24200		200		125	780
5035567	24225		225		125	870
5035568	24250		250		160	930
5035569	24315		315		180	1120
5043180	24350		350		195	1225
5043181	24400		400		250	1355
5043695	24450		450		250	1505
5043199	24500		500		315	1665
5043696	24600		600		315	1955
5043079	27125	M27	125	39	56	785
5035570	27150		150		80	870
5035571	27200		200		125	1070
5043080	27225		225		160	1160
5035572	27250		250		160	1260
5035573	27315		315		195	1410
5035574	27400		400		250	1835
5043081	27500		500		315	2230
5043082	30125	M30	125	43	56	960
5040941	30150		150		80	1080
5035575	30200		200		125	1320
5035576	30250		250		160	1550
5035577	30315		315		195	1860
5035578	30400		400		250	2250
5043083	30500		500		315	2730
5043084	30700		700		400	3670
5035579	36160	M36	160	51	80	1725
5043184	36200		200		125	1965
5043185	36250		250		160	2335
5035580	36315		315		195	2775
5043186	36400		400		250	3365
5043187	36500		500		315	4165
5043188	36700		700		400	5405

Si eseguono su richiesta misure non a catalogo / Other sizes can be supplied on request.

Su richiesta è disponibile la fornitura dell'attestato di controllo 2.2. / On demand it is available the supply of certificates 2.2.

### PRIGIONIERI SINGOLI SINGLE STUDS

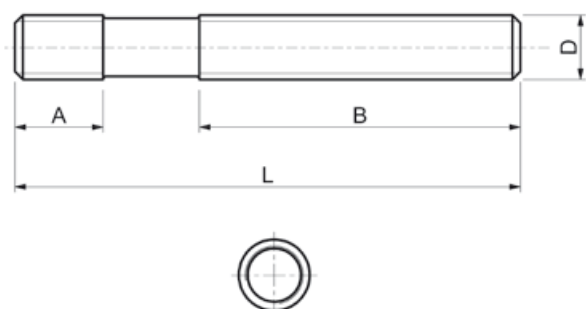

Materiale: 42CrMoS4 Classe 10.9. Filetto ottenuto per rullatura.  
Diametro medio sulla parte non filettata.

Material: 42CrMoS4 Class 10.9. Rolled thread.  
Average diameter on the non-threaded part.

Code	Model S321	D	L	A	B	
5035585	08040	M8	40	11	20	13
5035586	08060		63		40	20
5035587	08080*		80		50	25
5035588	08100		100		63	30
5035589	08125		125		75	36
5035591	08160*		160		100	45
5035592	08200*		200		100	65
5035593	10050	M10	50	13	25	25
5035594	10060*		63		35	30
5035595	10080		80		50	40
5035596	10100*		100		75	50
5035597	10125		125		75	65
5035600	10160*		160		100	80
5035601	10200		200		125	100
5035603	12050	M12	50	15	25	37
5035604	12060*		63		32	45
5035606	12080		80		50	55
5035607	12100*		100		63	70
5035608	12125		125		75	90
5035609	12160*		160		100	115
5035610	12200		200		125	140
5035611	12225*		225		160	165
5035612	12250*		250		160	180
5035613	14060*	M14	63	17	32	65
5035614	14080*		80		50	80
5035615	14100*		100		63	95
5035617	14125*		125		75	123
5035618	14160*		160		100	150
5035619	14200*		200		125	195
5035620	14225*		225		160	225
5035621	14250*		250		160	240

Code	Model S321	D	L	A	B	
5035624	16065	M16	63	19	35	85
5035625	16080*		80		50	105
5035626	16100		100		63	130
5035627	16125*		125		75	160
5035629	16160		160		100	220
5035630	16200*		200		125	280
5035631	16225*		225		160	295
5035632	16250		250		160	325
5035633	16315*		315		180	425
5035634	16350*		350		180	450
5035635	16400*		400		250	500
5035636	16450*		450		250	550
5035637	16500*		500		315	600
5035638	18080*	M18	80	23	50	130
5035639	18100*		100		50	165
5035640	18125*		125		75	200
5035642	18160*		160		100	255
5035643	18200*		200		125	320
5035644	18225*		225		150	365
5035645	18250*		250		150	400
5035646	18315*		315		180	500
5035647	18400*		400		250	640
5035649	20080	M20	80	27	30	165
5035651	20100*		100		50	205
5035652	20125		125		70	255
5035654	20160*		160		100	325
5035655	20200		200		125	410
5035656	20225*		225		160	465
5035657	20250*		250		160	510
5035658	20315		315		195	640
5035659	20350*		350		195	720
5035660	20400*		400		250	820

Si eseguono su richiesta misure non a catalogo / Other sizes can be supplied on request.

Si eseguono su richiesta misure non a catalogo / Other sizes can be supplied on request.

Su richiesta è disponibile la fornitura dell'attestato di controllo 2.2. / On demand it is available the supply of certificates 2.2.

\* Misura non inclusa nella norma DIN 6379 / Size not included in the DIN 6379 standard



## PRIGIONIERI SINGOLI SINGLE STUDS

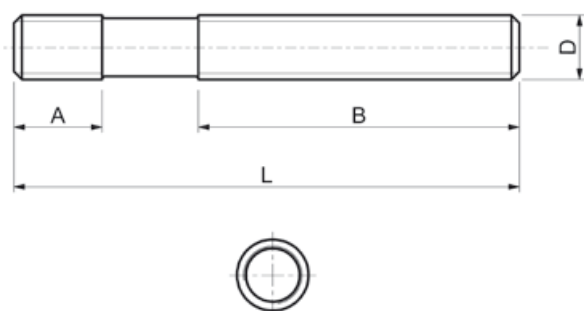

Materiale: 42CrMoS4 Classe 10.9. Filetto ottenuto per rullatura.  
Diametro medio sulla parte non filettata.

Material: 42CrMoS4 Class 10.9. Rolled thread.  
Average diameter on the non-threaded part.

Code	Model S321	D	L	A	B	
5035661	20450*		450	27	250	930
5035662	20500*		500		315	1020
5035664	20600*		600		315	1220
5035665	20650*		650		315	1350
5035666	20700*		700		400	1420
5035667	20800*		800		400	1630
5035668	20900*		900		400	1850
5035671	22100*	M22	100	31	45	270
5035672	22125*		120		63	300
5035673	22160*		160		100	430
5035674	22200*		200		125	500
5035675	22225*		225		160	570
5035676	22250*		250		160	670
5035678	22315*		315		180	750
5035679	22350*		350		195	840
5035680	22400*		400		250	950
5035682	22500*		500		315	1260
5035684	24100	M24	100	35	45	290
5035686	24125*		125		70	380
5035688	24160		160		100	470
5035689	24200*		200		125	580
5035690	24225*		225		125	670
5035691	24250		250		160	730
5035692	24315*		315		180	920
5035693	24350*		350		195	1020
5035694	24400		400		250	1150
5035695	24450*		450		250	1300
5035696	24500*		500		315	1460
5035698	24600*		600		315	1750
5035704	27125*	M27	125	39	56	485
5035705	27150*		150		80	570
5035706	27200*		200		125	770

Si eseguono su richiesta misure non a catalogo / Other sizes can be supplied on request.

Code	Model S321	D	L	A	B	
5035707	27225*		225	39	160	860
5035708	27250*		250		160	960
5035709	27315*		315		195	1110
5035710	27400*		400		250	1535
5035711	27500*		500		315	1930
5035713	30125	M30	125	43	56	590
5035714	30150*		150		80	710
5035715	30200*		200		125	950
5035716	30250*		250		160	1180
5035717	30315		315		195	1490
5035718	30400*		400		250	1880
5035719	30500		500		315	2360
5035721	30700*		700		400	3300
5035723	36160	M36	160	51	80	1100
5035724	36200*		200		125	1340
5035725	36250		250		160	1710
5035726	36315*		315		195	2150
5035727	36400		400		250	2740
5035728	36500*		500		315	3540
5035730	36700*		700		400	4780

Si eseguono su richiesta misure non a catalogo / Other sizes can be supplied on request.

Su richiesta è disponibile la fornitura dell'attestato di controllo 2.2. / On demand it is available the supply of certificates 2.2.

\* Misura non inclusa nella norma DIN 6379 / Size not included in the DIN 6379 standard

# S5909-S5911-S5914-S5917

## PRIGIONIERI A DISEGNO STUDS ON DRAWING



Materiale: 42CrMoS4 Classe 10.9. Filetto ottenuto per rullatura.  
Diametro medio sulla parte non filettata.

Su richiesta la S.P.D. grazie alla produzione diretta, è in grado di fornire prigionieri anche con misure fuori catalogo. Basta inviare una semplice richiesta d'offerta con le quantità e le caratteristiche desiderate, senza alcun impegno.

Material: 42CrMoS4 Class 10.9. Rolled thread. Average diameter on the non-threaded part.

On request S.P.D. thanks of his own production, is able to supply single studs also with special dimensions. It need a simply demand of an offer specifying quantity and characteristic needed, withouth any obligation on your part.

Esempio/Example:

Prigionieri Studs	Gambo e Radice Shank and Root	Lunghezza radice Root Lenght
UNI 5909	Passo grosso/ Coarse Thread	Corta/Short = 1 diam.
UNI 5911	Passo grosso/ Coarse Thread	Media/Medium = 1,5 diam.
UNI 5914	Passo grosso/ Coarse Thread	Lunga/Long = 2 diam.
UNI 5917	Passo grosso/ Coarse Thread	Extra lunga/Extra Long = 2,5 diam.

0 altri con dimensioni e lunghezza filettature a richiesta del Cliente. / Or other dimensions and thread lenght on request.

Su richiesta è disponibile la fornitura dell'attestato di controllo 2.2. / On demand it is available the supply of certificates 2.2.

# S330

DADI BASSI TORNITI  
TURNED SHORT NUTS

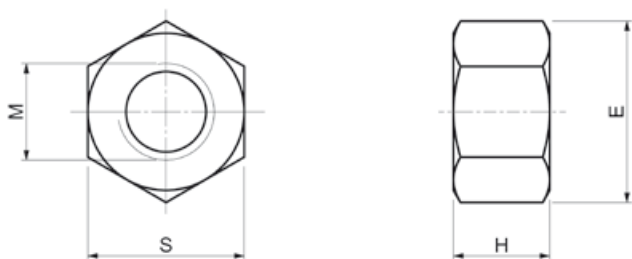

Materiale: Acciaio automatico da bonifica

Material: Automatic alloy steel

Code	Model S330	M	S	E	H	
5035750	08008	8	13	14,8	8	6
5035751	10010	10	17	19,6	10	15
5035752	12012	12	19	21,5	12	20
5035753	14014	14	22	25	14	30
5035754	16016	16	24	27,5	16	40
5035755	18018	18	27	31	18	60
5035756	20020	20	30	34,6	20	80
5035758	22022	22	32	36,9	22	95
5035759	24024	24	36	41,6	24	135
5035760	27027	27	41	47,3	27	195
5035761	30030	30	46	53,1	30	275
5035762	36036	36	55	63,5	36	465
5035763	42042	42	65	75	42	790
5035764	48048	48	75	86,5	48	1200

Si eseguono su richiesta misure non a catalogo / Other sizes can be supplied on request.

# S340

DIN 6330B

DADI ALTI TORNITI  
TURNED TALL NUTS

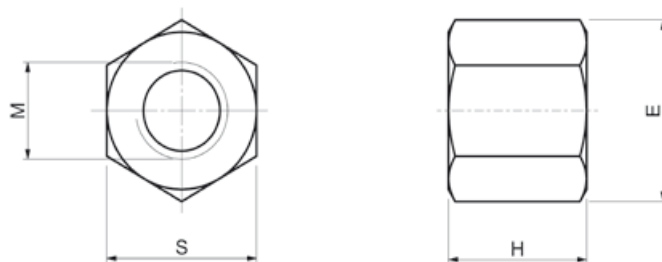

Materiale: Acciaio automatico da bonifica

Material: Automatic alloy steel

Code	Model S340	M	S	E	H	
5035765	06009	6	10	11,5	9	5
5035766	08012	8	13	14,8	12	9
5035767	10015	10	17	19,6	15	20
5035770	12018	12	19	21,5	18	28
5035772	14021	14	22	25	21	45
5035774	16024	16	24	27,5	24	58
5035775	18027	18	27	31	27	83
5035776	20030	20	30	34,6	30	110
5035778	22033	22	32	36,9	33	130
5035781	24036	24	36	41,6	36	195
5035783	27041	27	41	47,3	40	280
5035784	30045	30	46	53,1	45	405
5035785	36054	36	55	63,5	54	715
5035787	42063	42	65	75	63	1170
5035788	48072	48	75	86,5	72	1800

Si eseguono su richiesta misure non a catalogo / Other sizes can be supplied on request.

# S350

DADI PROLUNGAMENTO  
EXTENSION NUTS

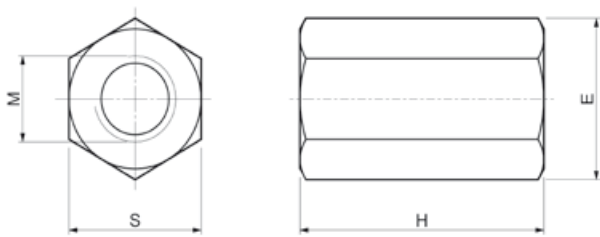

Materiale: Acciaio automatico da bonifica

Material: Automatic alloy steel

Code	Model S350	M	S	E	H	
5035789	06018	6	10	11,5	18	8
5035790	08024	8	13	14,8	24	19
5035791	10030	10	17	19,6	30	42
5035793	12036	12	19	21,5	36	64
5035795	14042	14	22	25	42	95
5035797	16048	16	24	27,5	48	120
5035798	18054	18	27	31	54	170
503584	20060	20	30	34,6	60	240
5035800	22066	22	32	36,9	66	280
5035801	24072	24	36	41,6	72	400
5035802	27081	27	41	47,3	81	600
5035803	30090	30	46	53,1	90	850
5035804	36108	36	55	63,5	108	1470
5035805	42126	42	65	75	126	2340
5035806	48144	48	75	86,5	144	3600

Si eseguono su richiesta misure non a catalogo / Other sizes can be supplied on request.

# S351

DIN 6331

DADI CON RONDELLA  
NUTS WITH WASHER

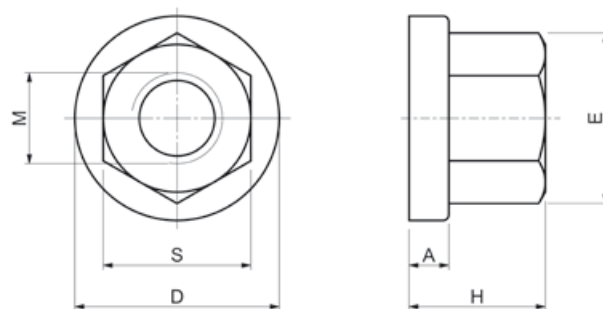

Materiale: Acciaio automatico da bonifica

Material: Automatic alloy steel

Code	Model S351	M	S	E	H	A	D	
5035807	00008	8	13	14,8	12	3,5	18	12
5035808	00010	10	17	19,6	15	4	22	21
5035809	00012	12	19	21,5	18	4	25	36
5035810	00014	14	22	25	21	4,5	28	51
5035811	00016	16	24	27,5	24	5	31	70
5035812	00018	18	27	31	27	5	34	95
5035813	00020	20	30	34,6	30	6	37	130
5035814	00022	22	32	36,9	33	6	40	160
5035815	00024	24	36	41,6	36	6	45	230
5035816	00027	27	41	47,3	40	8	51	320
5035817	00030	30	46	53,1	45	8	58	470
5035818	00036	36	55	63,5	54	10	68	800
5035819	00042	42	65	75	63	12	80	1340
5035820	00048	48	75	86,5	72	14	92	2040

Si eseguono su richiesta misure non a catalogo / Other sizes can be supplied on request.

# S360

DIN 508 - UNI 5531

## TASSELLI PER CAVE A "T"





Materiale: Acciaio da bonifica

Code	Model S360	M	D	A	B	C		
5035821	06008	6	7,7	13x13	10	6	8	9
5035823	08010	8	9,7	15x15	12	6	10	12
5035824	08012	8	11,7	18x18	14	7	12	22
5035829	10012	10						20
5035825	08014	8						41
5035831	10014	10	13,7	22x22	16	8	14	37
5035836	12014	12						35
5035826	08016	8						61
5035832	10016	10	15,7	25x25	18	9	16	59
5035838	12016	12						56
5035843	14016	14						52
5035827	08018	8						91
5035833	10018	10						87
5035839	12018	12	17,7	28x28	20	10	18	82
5035844	14018	14						70
5035848	16018	16						60

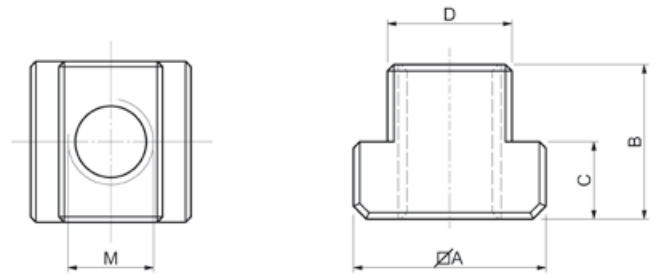
## NUTS FOR T-SLOTS



Material: Tempering steel

Code	Model S360	M	D	A	B	C		
5035849	16020	16	19,7	32x32	24	12	20	110
5035853	18020	18						100
5035850	16022	16						176
5035854	18022	18	21,7	35x35	28	14	22	163
5035857	20022	20						155
5035851	16024	16						260
5035858	20024	20	23,7	40x40	32	16	24	235
5035862	22024	22						220
5035852	16028	16						383
5035859	20028	20	27,7	44x44	36	18	28	355
5035863	22028	22						340
5035864	24028	24						322
5035865	24030	24	29,7	48x48	38	19	30	440
5035867	27032	27	31,6	50x50	40	20	32	460
5035868	30036	30	35,6	54x54	44	22	36	590
5035869	36042	36	41,6	65x65	52	26	42	1010



# S361

NR. 508R

## TASSELLI PER CAVE A "T" SENZA FORO BLANKS T-NUTS

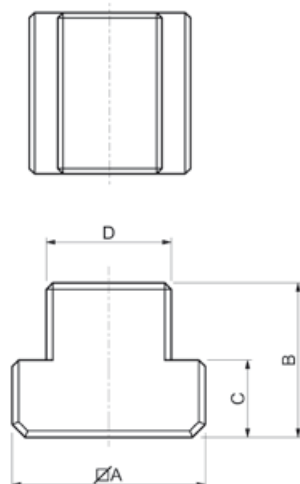
Materiale: Acciaio da bonifica  
Material: Tempering steel



Code	Model S361	D	A	B	C		
5035871	00008	7,7	13x13	10	6	8	10
5035872	00010	9,7	15x15	12	6	10	16
5035873	00012	11,7	18x18	14	7	12	27
5035874	00014	13,7	22x22	16	8	14	50
5035875	00016	15,7	25x25	18	9	16	70
5035876	00018	17,7	28x28	20	10	18	95
5035877	00020	19,7	32x32	24	12	20	150
5035878	00022	21,7	35x35	28	14	22	210
5035879	00024	23,7	40x40	32	16	24	300
5035880	00028	27,7	44x44	36	18	28	430
5035881	00032	31,6	50x50	40	20	32	630
5035882	00036	35,6	54x54	44	22	36	800
5035883	00042	41,6	65x65	52	26	42	1410

Si eseguono su richiesta misure non a catalogo / Other sizes can be supplied on request.

Su richiesta è disponibile la fornitura dell'attestato di controllo 2.2. / On demand it is available the supply of certificates 2.2.

# S362

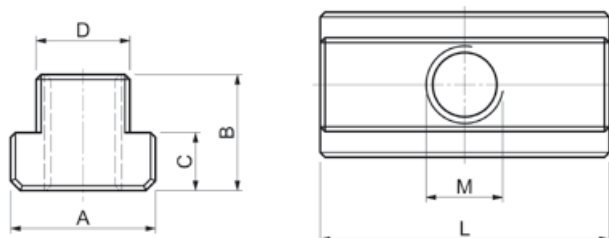

NR. 508L

TASSELLI PER CAVE A "T" DOPPIA LUNGHEZZA  
EXTENDED NUTS FOR T-SLOTS



Materiale: Acciaio da bonifica

Material: Tempering steel

Code	Model S362	M	D	L	A	B	C		
5035886	06008	6	7,7	26	13	10	6	8	14
5035888	08010	8	9,7	30	15	12	6	10	30
5035889	10012	10	11,7	36	18	14	7	12	49
5035892	12014	12	13,7	44	22	16	8	14	82
5035894	14016	14	15,7	50	25	18	9	16	120
5035896	16018	16	17,7	56	28	20	10	18	170
5035898	18020	18	19,7	64	32	24	12	20	260
5035899	20022	20	21,7	70	35	28	14	22	360
5035902	22024	22	23,7	80	40	32	16	24	535
5035903	24028	24	27,7	88	44	36	18	28	730
5035904	27032	27	31,6	100	50	40	20	32	1090
5035905	30036	30	35,6	108	54	44	22	36	1390

Si eseguono su richiesta misure non a catalogo / Other sizes can be supplied on request.

# S363

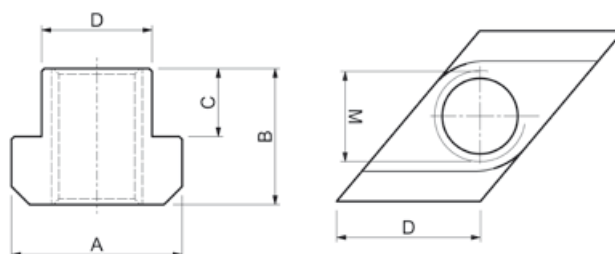

NR. 510

TASSELLI PER CAVE ROMBOIDALI  
NUTS FOR T-SLOTS "RHOMBUS"



Materiale: Acciaio da bonifica

Material: Tempering steel

Code	Model S363	M	D	A	B	C		
5035907	10012	10	11,7	18	14	7	12	14
5035909	10014	10	13,7	22	16	8	14	27
5035910	12014	12	13,7	22	16	8	14	22
5035911	14016	14	15,7	25	18	9	16	33
5035913	10018	10	17,7	28	20	10	18	64
5035914	16018	16	17,7	28	20	10	18	46
5035915	16020	16	19,7	32	24	12	20	79
5035916	18020	18	19,7	32	24	12	20	70
5035917	16022	16	21,7	35	28	14	22	119
5035918	20022	20	21,7	35	28	14	22	98
5035919	16028	16	27,7	44	36	18	28	278
5035920	20028	20	27,7	44	36	18	28	240
5035922	24028	24	27,7	44	36	18	28	215
5035923	30036	30	35,6	54	44	22	36	430

Si eseguono su richiesta misure non a catalogo / Other sizes can be supplied on request.

# S370

RONDELLE NORMALI TORNITE  
FLAT WASHERS



# S380

RONDELLE ALTE TORNITE  
THICK WASHERS



# S390

RONDELLE LARGHE TORNITE  
BROAD WASHERS

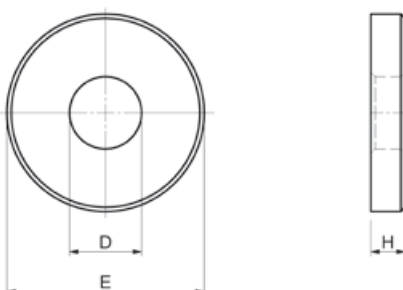
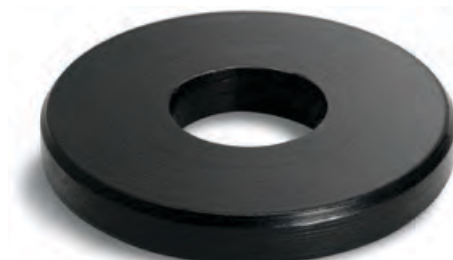

Materiale: Acciaio automatico da bonifica

Material: Automatic alloy steel

Code	Model S370	D	E	H	
5035936	00006	6,6	13	3,5	3
5035937	00008	8,4	18	4	6
5035939	00010	10,5	22	4	9
5035941	00012	13	28	5	20
5035943	00014	15	35	6	35
5035944	00016	17	35	6	35
5035945	00018	19	40	6	45
5035946	00020	21	40	6	45
5035947	00022	23	45	8	75
5035948	00024	25	45	8	70
5035949	00027	28	60	10	170
5035950	00030	31	60	10	161
5035951	00036	37	70	12	190
5035953	00042	43	80	12	260
5035954	00048	49	90	12	415

Si eseguono su richiesta misure non a catalogo /  
Other sizes can be supplied on request

Materiale: Acciaio automatico da bonifica

Material: Automatic alloy steel

Code	Model S380	D	E	H	
5036010	00006	6,6	20	8	17
5036011	00008	8,4	35	8	55
5036012	00010	10,5	35	8	55
5036013	00012	13	40	8	70
5036014	00014	15	40	10	85
5036015	00016	17	45	10	105
5036016	00018	19	45	10	100
5036017	00020	21	50	12	150
5036018	00022	23	50	12	140
5036019	00024	25	50	12	140
5036020	00027	28	60	14	175
5036021	00030	31	60	14	165

Si eseguono su richiesta misure non a catalogo /  
Other sizes can be supplied on request

Materiale: Acciaio automatico da bonifica

Material: Automatic alloy steel

Code	Model S390	D	E	H	
5036022	00006	6,6	17	3,5	5
5036023	00008	8,4	23	4	10
5036026	00010	10,5	28	4	16
5036027	00012	13	35	5	35
5036030	00014	15	40	5	40
5036032	00016	17	45	6	70
5036034	00018	19	45	6	60
5036035	00020	21	50	6	73
5036036	00022	23	50	8	92
5036037	00024	25	60	8	170
5036038	00027	28	68	10	240
5036039	00030	31	68	10	230
5036040	00036	38	80	12	350
5036041	00042	44	100	15	735
5036042	00048	50	100	17	775

Si eseguono su richiesta misure non a catalogo /  
Other sizes can be supplied on request

# S375.C

**RONDELLE CONVESSE**  
SPHERICAL SEAT WASHERS

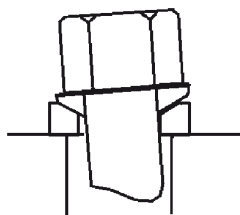
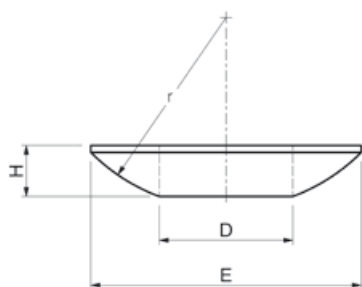

Materiale: Acciaio automatico da bonifica

Material: Automatic alloy steel

Code	Model S375.C	D	E	r	H	
5035956	0006	6,4	12	9	2,3	1
5035957	0008	8,4	17	12	3,2	2,5
5035958	0010	10,5	21	15	4	5
5035959	0012	13	24	17	4,6	7
5035960	0014	15	28	22	5	10
5035961	0016	17	30	22	5,3	12
5035962	0020	21	36	27	6,3	23
5035963	0024	25	44	32	8,2	42
5035964	0027	28	50	37	9,5	80
5035965	0030	31	56	41	11,2	87
5035966	0036	37	68	50	14	184
5035968	0042	43	78	58	17	297
5035969	0048	50	92	67	21	525

Si eseguono su richiesta misure non a catalogo /  
Other sizes can be supplied on request

# S375.D

**RONDELLE CONCAVE**  
DISHED WASHERS

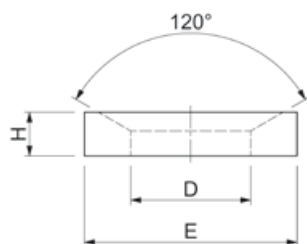

Materiale: Acciaio automatico da bonifica

Material: Automatic alloy steel

Code	Model S375.D	D	E	H	
5035973	0006	7,1	12	2,8	1,5
5035974	0008	9,6	17	3,5	4
5035975	0010	12	21	4,2	6,5
5035976	0012	14,2	24	5	10
5035977	0014	16,5	28	5,6	18
5035978	0016	19	30	6,2	19
5035979	0020	23,2	36	7,5	32
5035980	0024	28	44	9,5	63
5035981	0027	31,5	50	10,8	85
5035982	0030	35	56	12	133
5035983	0036	42	68	15	236
5035985	0042	49	78	18	365
5035986	0048	56	92	22	641

Si eseguono su richiesta misure non a catalogo /  
Other sizes can be supplied on request

# S375.G

**RONDELLE CONCAVE**  
DISHED WASHERS

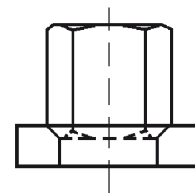
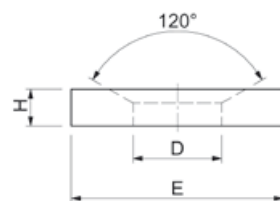

Materiale: Acciaio automatico da bonifica

Material: Automatic alloy steel

Code	Model S375.G	D	E	H	
5035989	0006	7,1	17	4	5,5
5035990	0008	9,6	23	4	13
5035991	0010	12	28	5	19
5035992	0012	14,2	35	5	32
5035993	0014	16,5	40	5	48
5035994	0016	19	45	6	56
5035995	0020	23,2	50	8	94
5035996	0024	28	60	10	169
5035997	0030	35	68	10	218
5035998	0036	42	80	12	350
5035999	0042	49	100	15	640
5036000	0048	56	110	17	830





Si eseguono su richiesta misure non a catalogo /  
Other sizes can be supplied on request



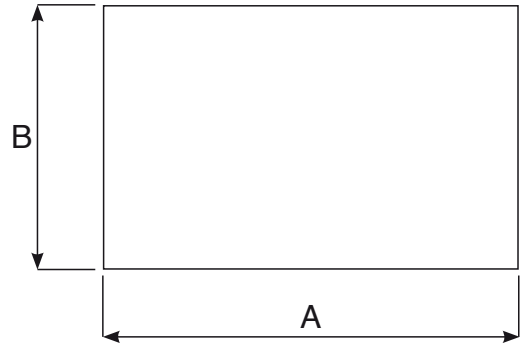



# S420

## CONTENITORI CON VITI TESTA MARTELLLO SERIE S310 + RONDELLE S370 SET OF HAMMERHEAD BOLTS COMPLETE TYPE S310 + WASHERS S370



Code	Model S420		D	Cava	AxB
<b>5036057</b>	00010		M10	10	S310.10040
					S310.10060
					S310.10080
					S310.10100
					S310.10125
					S310.10150
					S310.10170
					S370.00010
					Nr.10
					Kg 3,2
<b>5036058</b>	00012		M12	12	S310.12050
					S310.12060
					S310.12080
					S310.12100
					S310.12125
					S310.12150
					S310.12170
					S310.12200
					S310.12230
					S370.00012
Nr.10					
Kg 5,2					
<b>5036059</b>	00014		M14	14	S310.14050
					S310.14060
					S310.14080
					S310.14100
					S310.14125
					S310.14150
					S310.14170
					S310.14200
					S310.14230
					S370.00014
Nr.10					
Kg 6,5					
<b>5036060</b>	00016		M16	16	S310.16060
					S310.16080
					S310.16100
					S310.16125
					S310.16150
					S310.16170
					S310.16200
					S310.16230
					S370.00016
					Nr.10
Kg 8,5					

Code	Model S420		D	Cava	AxB
<b>5036061</b>	00018		M18	18	S310.18080
					S310.18100
					S310.18125
					S310.18150
					S310.18170
					S310.18200
					S310.18230
					S370.00018
					Nr.10
					Kg 8,8
<b>5036062</b>	00020		M20	20	S310.20080
					S310.20100
					S310.20125
					S310.20150
					S310.20170
					S310.20200
					S310.20230
					S370.00020
					Nr.10
					Kg 11,5
<b>5036063</b>	00022		M22	22	S310.22080
					S310.22100
					S310.22125
					S310.22150
					S310.22170
					S310.22200
					S310.22230
					S370.00022
					Nr.10
					Kg 13
<b>5036064</b>	00024		M24	24	S310.24080
					S310.24100
					S310.24125
					S310.24150
					S310.24170
					S310.24200
					S310.24230
					S370.00024
					Nr.10
					Kg 17

Si eseguono su richiesta misure non a catalogo / Other sizes can be supplied on request





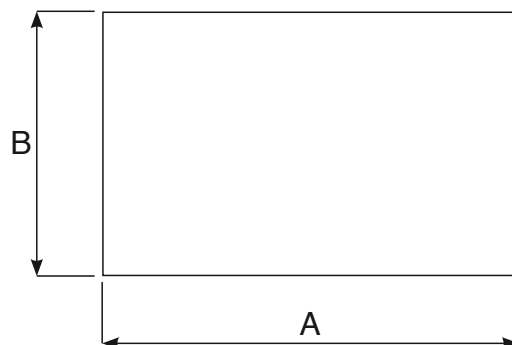
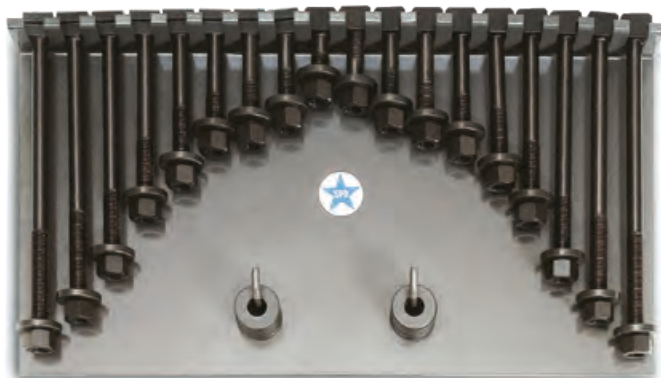

Si eseguono su richiesta misure non a catalogo / Other sizes can be supplied on request

Su richiesta è disponibile la fornitura dell'attestato di controllo 2.2. / On demand it is available the supply of certificates 2.2.

# S425

## CONTENITORI CON VITI TESTA MARTELLO SERIE S315 + RONDELLE S390 SET OF HAMMERHEAD BOLTS COMPLETE TYPE S315 + WASHERS S390



Code	Model S425		D	Cava	AxB		
5036065	00012		M12	14	S315.12050	Nr.4	cm
					S315.12063	Nr.4	50X25
					S315.12080		
					S315.12100	Nr.2	
					S315.12125		
					S315.12150		
					S315.12200		Kg
S390.00012	Nr.10	5,8					
5036066	00014		M14	16	S315.14063		cm
					S315.14100		50x25
					S315.14160	Nr.4	
					S315.14230		Kg
S390.00014	Nr.10	7,5					
5036067	00016		M16	18	S315.16063		cm
					S315.16080		50x25
					S315.16100		
					S315.16125		
					S315.16160	Nr.2	
					S315.16200		
					S315.16230		
S315.16250		Kg					
S390.00016	Nr.10	10					
5036068	00020		M20	22	S315.20080		cm
					S315.20100		60X25
					S315.20125		
					S315.20160	Nr.2	
					S315.20200		
					S315.20230		
					S315.20315		Kg
S390.00020	Nr.10	14					
5036069	00024		M24	28	S315.24100		cm
					S315.24125		60X25
					S315.24160		
					S315.24200	Nr.2	
					S315.24230		
					S315.24250		
					S315.24315		Kg
S390.00024	Nr.10	23					

Contenitore vuoto per confezioni S420 - S425 - S430

Empty metal case for packing S420 - S425 - S430

Code	Model 228	Descrizione Description	AxB (cm)	H (cm)	
5020754	S420.10	Contenitore vuoto per viti M10	30x53	2,5	1400
5020755	S420.12	Contenitore vuoto per viti M12	30x53	3,6	2200
5020756	S420.14	Contenitore vuoto per viti M14	30x53	4,3	2400
5020757	S420.16	Contenitore vuoto per viti M16	30x53	4,5	2600
5020758	S420.18	Contenitore vuoto per viti M18	30x53	5,5	2600
5020759	S420.20	Contenitore vuoto per viti M20	30x60	5,5	3000
5020760	S420.22	Contenitore vuoto per viti M22	30x60	6	3000
5020761	S420.24	Contenitore vuoto per viti M24	30x60	6	3000

Si eseguono su richiesta misure non a catalogo / Other sizes can be supplied on request.

Su richiesta è disponibile la fornitura dell'attestato di controllo 2.2. / On demand it is available the supply of certificates 2.2.

# S430

CONTENITORI CON PRIGIONIERI S320 MONTATI CON TASSELLO S360 + RONDELLE S370  
SET OF STUDS S320 COMPLETE WITH "T" SLOT NUT S360 + WASHERS S370

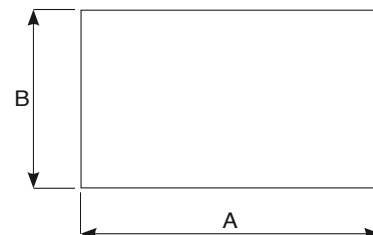
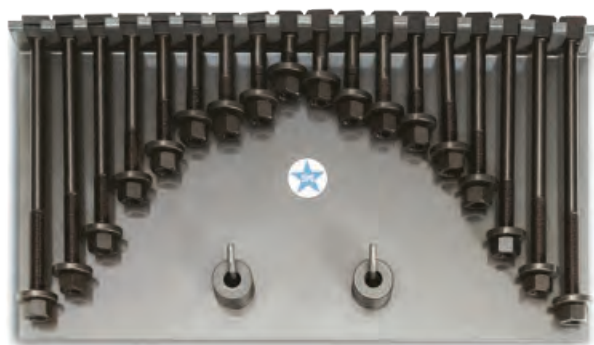

Code	Model S430		D	Cava	AxB				
5036070	00008	Nr.2	M8	10	S320.08040				
	S320.08060								
	S320.08080								
	S320.08100								
	S320.08125								
	S320.08160								
	S320.08200								
	S360.08010								
	S370.00008								
	S320.10060								
5036071	00010	Nr.2	M10	12	S320.10080				
	S320.10100								
	S320.10120								
	S320.10160								
	S320.10200								
	S360.10012								
	S370.00010								
	S320.12060								
	5036072				00012	Nr.2	M12	14	S320.12080
					S320.12100				
S320.12125									
S320.12160									
S320.12200									
S320.12225									
S320.12250									
S360.12014									
S370.00012									
S320.14060									
5036073	00014	Nr.2	M14	16	S320.14080				
	S320.14100								
	S320.14120								
	S320.14160								
	S320.14200								
	S320.14225								
	S320.14250								
	S360.14016								
	S370.00014								

Code	Model S430		D	Cava	AxB
5036074	00016	Nr.2	M16	18	S320.16065
	S320.16080				
	S320.16100				
	S320.16125				
	S320.16160				
	S320.16200				
	S320.16250				
	S320.16315				
	S360.16018				
	S370.00016				
5036075	00018	Nr.2	M18	20	S320.18080
	S320.18100				
	S320.18125				
	S320.18160				
	S320.18200				
	S320.18250				
	S320.18315				
	S360.18020				
	S370.00018				
	5036076				00020
S320.20100					
S320.20125					
S320.20160					
S320.20200					
S320.20250					
S320.20315					
S360.20022					
S370.00020					
5036077		00022	Nr.2	M22	24
	S320.22120				
	S320.22160				
	S320.22200				
	S320.22225				
	S320.22250				
	S320.22315				
	S360.22024				
	S370.00022				
	5036078	00024			
S320.24125					
S320.24160					
S320.24200					
S320.24225					
S320.24250					
S320.24315					
S360.24028					
S370.00024					

Su richiesta è disponibile la fornitura dell'attestato di controllo 2.2. / On demand it is available the supply of certificates 2.2.



# VT10

## VITI PER TORRETTA TURRET BOLTS

Materiale: Acciaio automatico da bonifica.

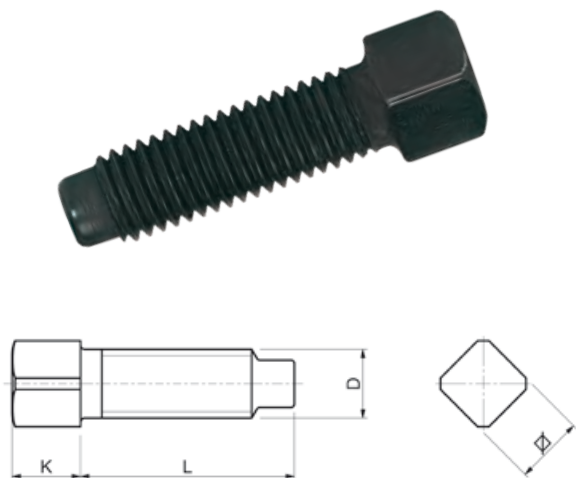
Material: Automatic alloy steel.



Code	Model VT10	D	L	K		Torretta	
5036816	00008	M8	25	8	8	A	13
5036817	00010	M10	35	10	10	A	23
5036818	00012	M12	46	12	12	B-C	44
5036819	00014	M14	46	14	14	D-F	64
5036820	00016	M16	56	16	16	-	102
5036823	00308	3/8 W	36	9	9	A	20
5036827	00516	5/16 W	25	8	8	M	11
5036828	00716	7/16 W	48	10	10	B	35
5036821	00102	1/2 W	48	12	12	C	48
5036829	00916	9/16 W	58	14	14	D-F	76

Si eseguono su richiesta misure non a catalogo / Other sizes can be supplied on request.

# VT6050

## A DISEGNO ON DRAWING

### Tipo A

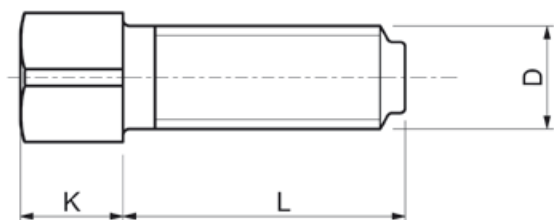

### Tipo B

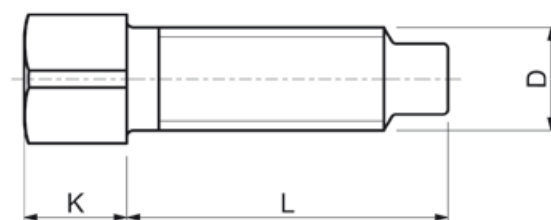

Su richiesta del Cliente è possibile la fornitura di viti con la lunghezza desiderata. / Screws with special length can be supplied on request.

# CA10

CHIAVI PER AUTOCENTRANTI  
SELF-CENTERING CHUCKS KEYS

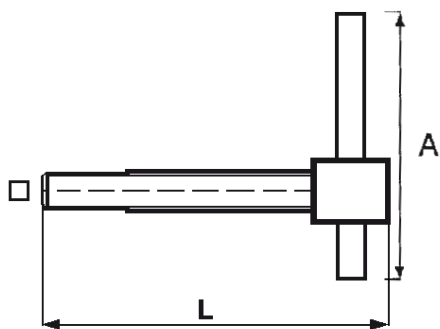

Tolleranze quadro maschio -0,05/-0,1. Materiale: 18NiCrMo5.

Male square tolerance -0,05/-0,1. Material: 18NiCrMo5.

Code	Model CA10		L	A	
5027883	00006	6	55	120	0,065
5027884	00007	7	60	120	0,070
5027885	00008	8	70	130	0,125
5027886	00009	9	80	150	0,165
5027887	00010	10	90	200	0,290
5027888	00011	11	90	250	0,375
5027889	00012	12	90	250	0,425
5027890	00013	13	105	310	0,675
5027891	00014	14	105	350	0,810
5027892	00015	15	130	450	1,280
5027893	00016	16	130	430	1,310
5027894	00017	17	130	450	1,360
5027895	00018	18	150	450	1,510
5027896	00019	19	150	450	1,580
5027900	00022	22	165	500	2,070

Si eseguono su richiesta misure non a catalogo / Other sizes can be supplied on request.

# CA20

CHIAVI PER AUTOCENTRANTI  
ANTINFORTUNISTICHE

KEYS FOR SELF-CENTERING  
CHUCKS SAFETY TYPE

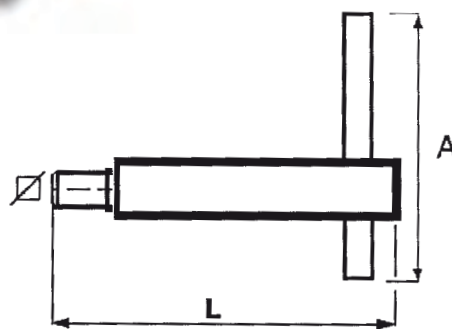

Materiale: C45

Material: C45.

Code	Model CA20		L	A	
5027901	00007	7	130	300	0,530
5027902	00008	8	130	250	0,510
5027903	00009	9	130	300	0,400
5027904	00010	10	130	330	0,640
5027905	00011	11	130	330	0,630
5027906	00012	12	130	330	0,800
5027907	00013	13	130	330	0,800
5027908	00014	14	130	330	0,810
5027909	00015	15	130	300	0,790
5027910	00016	16	130	400	0,990
5027911	00017	17	130	350	0,880
5027912	00018	18	130	350	0,950

Si eseguono su richiesta misure non a catalogo / Other sizes can be supplied on request.

# CL10

CHIAVI PER AUTOCENTRANTI CAM-LOCK  
CAM-LOCK KEYS FOR SELF-CENTERING  
CHUCKS

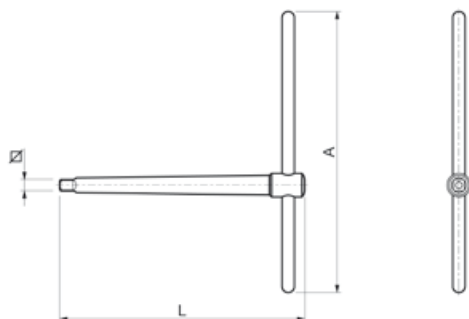

Tolleranze quadro maschio -0,05/-0,1. Materiale: 18NiCrMo5.

Male square tolerance -0,05/-0,1. Material: 18NiCrMo5.

Code	Model CL10	□	L	A	kg
5027915	00010	10	218	250	0,565
5027916	00011	11	218	250	0,630
5027917	00012	12	218	250	0,750
5027918	00013	13	218	250	0,865
5027919	00014	14	218	310	1,060
5027922	00016	16	218	310	1,140

Si eseguono su richiesta misure non a catalogo / Other sizes can be supplied on request.

# CP10

CHIAVI PER PIATTAFORME  
KEYS FOR PLATFORMS

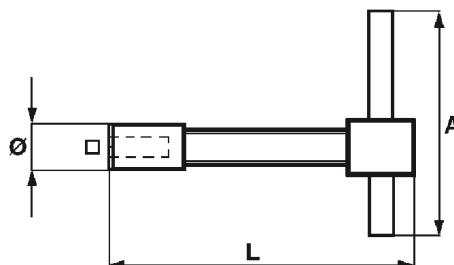

Tolleranze quadro femmina +0,1/+0,2  
Materiale: C45.

Female square tolerance: +0,1/+0,2  
Material: C45.

Code	Model CP10	□	∅	L	A	kg
5027949	00008	8	18	90	200	0,265
5027950	00009	9	18	90	200	0,270
5027951	00010	10	22	110	285	0,555
5027952	00011	11	23	120	320	0,680
5027953	00012	12	24	130	340	0,740
5027954	00013	13	25	140	350	0,780
5027955	00014	14	25	140	350	0,790
5027956	00015	15	29	180	450	1,280
5027957	00016	16	29	180	450	1,500
5027958	00017	17	31	200	500	1,810
5027959	00018	18	34	220	420	1,890
5027960	00019	19	34	180	500	1,840
5027963	00020	20	34,50	230	500	2,000
5027964	00022	22	40	230	500	2,400
5027965	00024	24	42	230	500	2,700
5027967	00025	25	42	230	500	2,800
5027968	00027	27	44	230	500	3,300

Si eseguono su richiesta misure non a catalogo / Other sizes can be supplied on request.

# CP30

CHIAVI A PIPA  
ELBOW WRENCHES

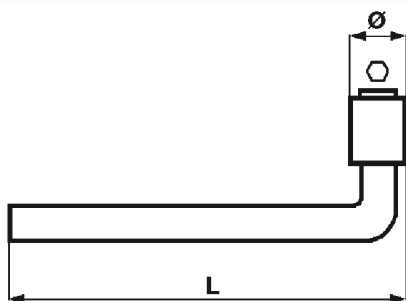

Tolleranze esagono femmina +0,1/+0,2  
Materiale: 39NiCrMo3.

Female hexagon tolerance: +0,1/+0,2  
Material: 39NiCrMo3.

Code	Model CP30		ø	L	
5027971	00012	12	18	160	0,165
5027972	00014	14	21	180	0,265
5027973	00017	17	26	220	0,365
5027974	00019	19	28	280	0,610
5027975	00021	21	30	350	0,970

Si eseguono su richiesta misure non a catalogo / Other sizes can be supplied on request.

# CT10

CHIAVI PER TORRETTE PORTAUTENSILI  
KEYS FOR MACHINE TOOL TURRETS

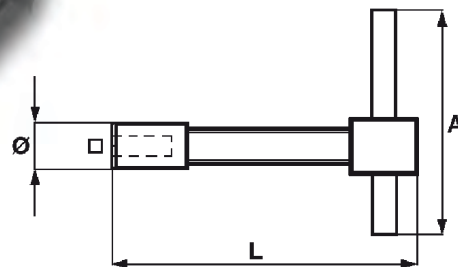

Tolleranze quadro femmina +0,1/+0,2  
Materiale: C45.

Female square tolerance: +0,1/+0,2  
Material: C45.

Code	Model CT10		ø	L	A	
5027976	00007	7	14	18	67	0,070
5027977	00008	8	14	80	60	0,090
5027978	00009	9	17	80	100	0,145
5027979	00010	10	19	100	100	0,205
5027980	00011	11	21	110	115	0,250
5027981	00012	12	21	110	115	0,290
5027982	00013	13	24	110	115	0,355
5027983	00014	14	25	120	150	0,435
5027984	00016	16	28	125	150	0,485

Si eseguono su richiesta misure non a catalogo / Other sizes can be supplied on request.

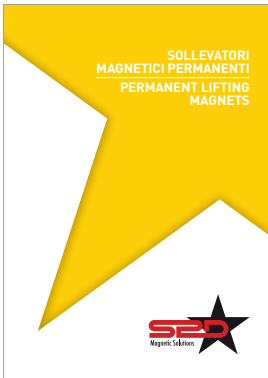
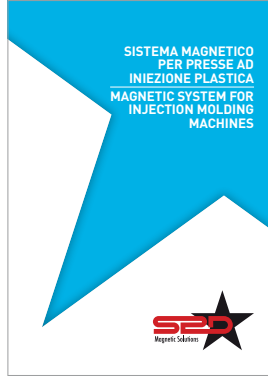
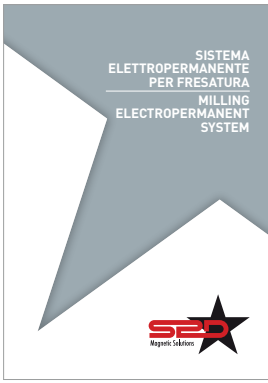

FOLLOW  
**THE STAR**  
OF MAGNETIC  
SOLUTIONS

**S.P.D. S.p.A.**

Via Galileo Galilei, 2/4  
24043 Caravaggio (BG) ITALY  
Tel. +39 0363 546 511  
Fax +39 0363 52578  
info@spd.it - [www.spd.it](http://www.spd.it)



Organizzazione con Sistema di Gestione certificato ISO 3834